

References

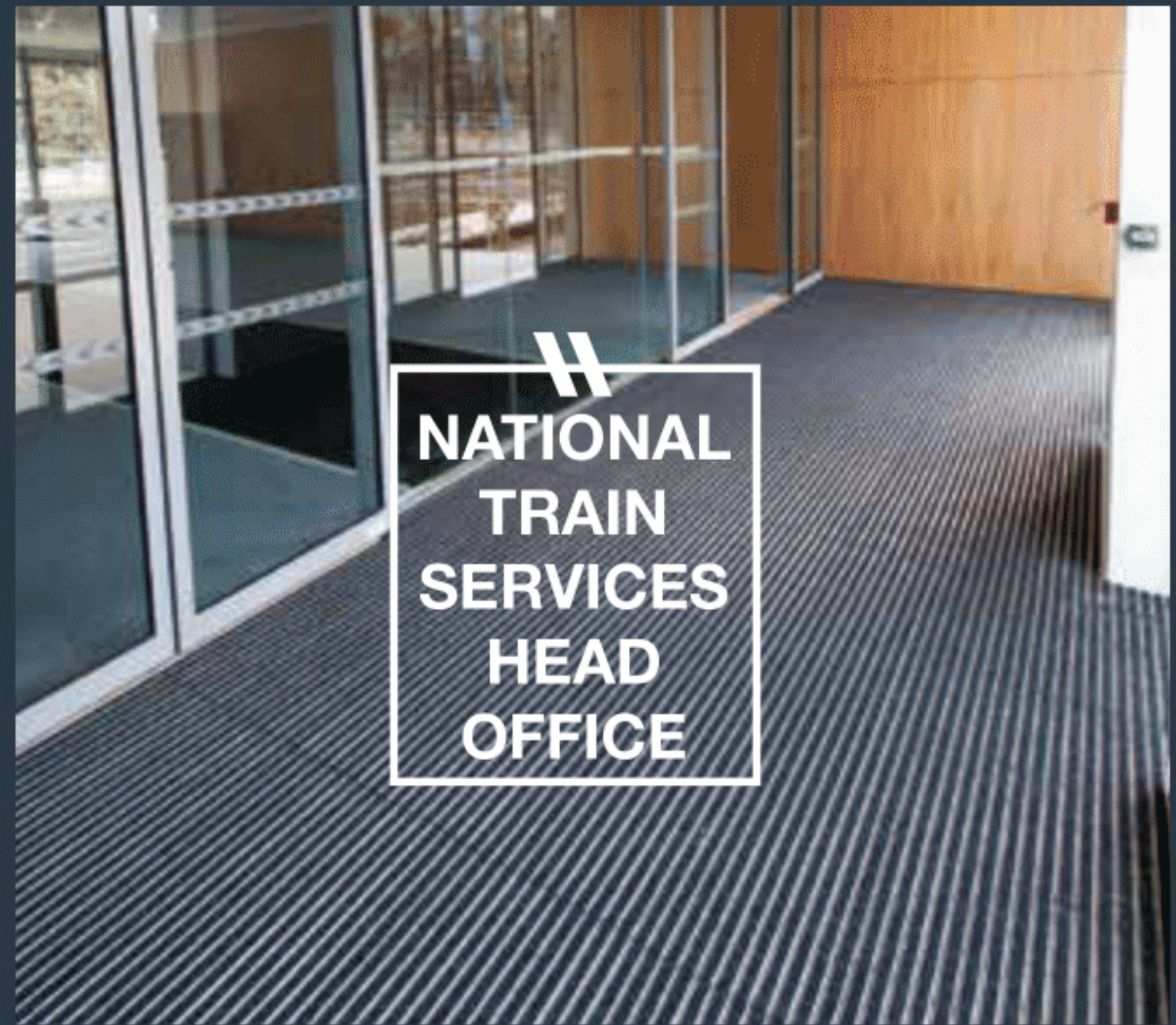



## ROMAT



Rolls up/ Attractive and decorative / Made to measure

### ► CONSTRUCTION:

The ROMAT range is made of specially designed heavy duty dust barrier rubber and carpet strips (some with fire rating) inserted in MILL ALUMINIUM profile sections. The profiles are linked together with flexible PVC strips placed underneath the profiles, deadening traffic noise and enabling the mat to be rolled up.

### ► MAINTENANCE:

Dirt passes between the profiles and falls into the matwell. The mat can easily be rolled up for vacuuming.



In most cases, the last ROMAT mat profile will be black PVC, allowing a clean, completely safe cut to fit.

Area 1

Area 2

Frequent

Average  
(100 kg)

Cfl-s1

ROLL-UP

Open

12 mm  
thickness

17 mm  
thickness

22 mm  
thickness

### 1 Loop pile Insert

100% polypropylene needle felt  
Scrapes / absorbs - Indoor

### 2 Tufted brush Insert

Tufted polyamide 6.6 multifilament,  
giving a scraping-absorbing effect.  
Indoor

### 3 Fluted rubber Insert

Black colour. Scrapes - Indoor /  
Outdoor (Covered places)

## ROMAT 12 MM

Price / m<sup>2</sup>

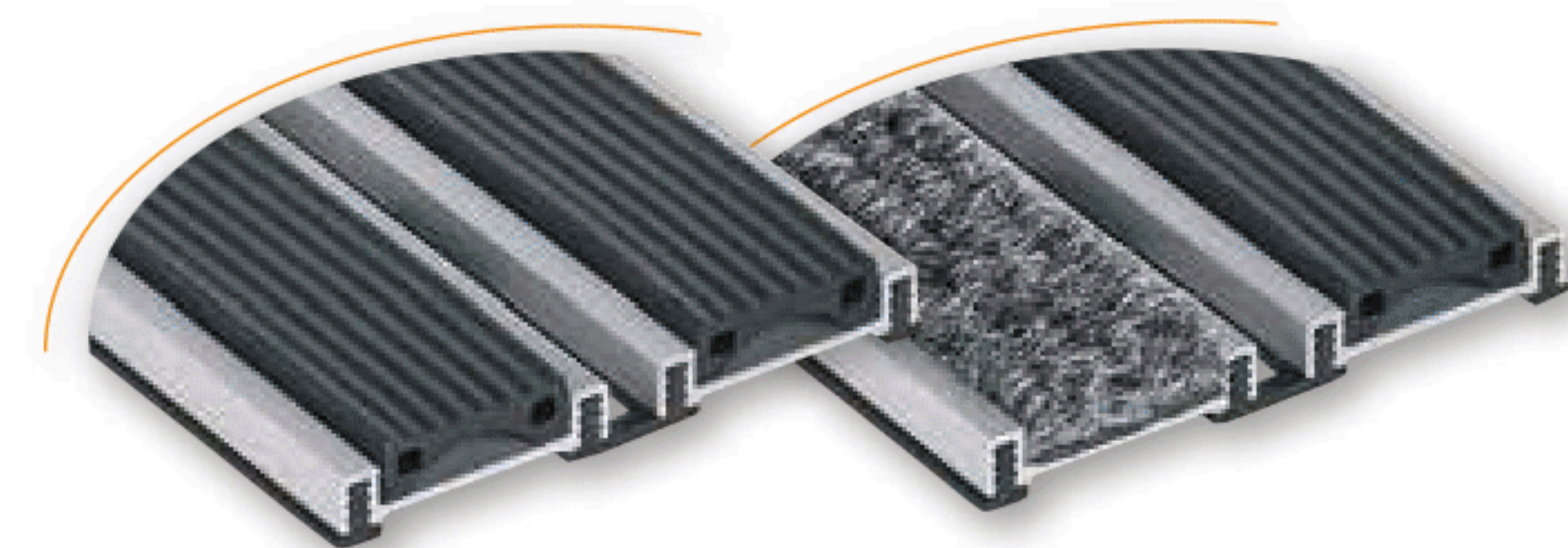
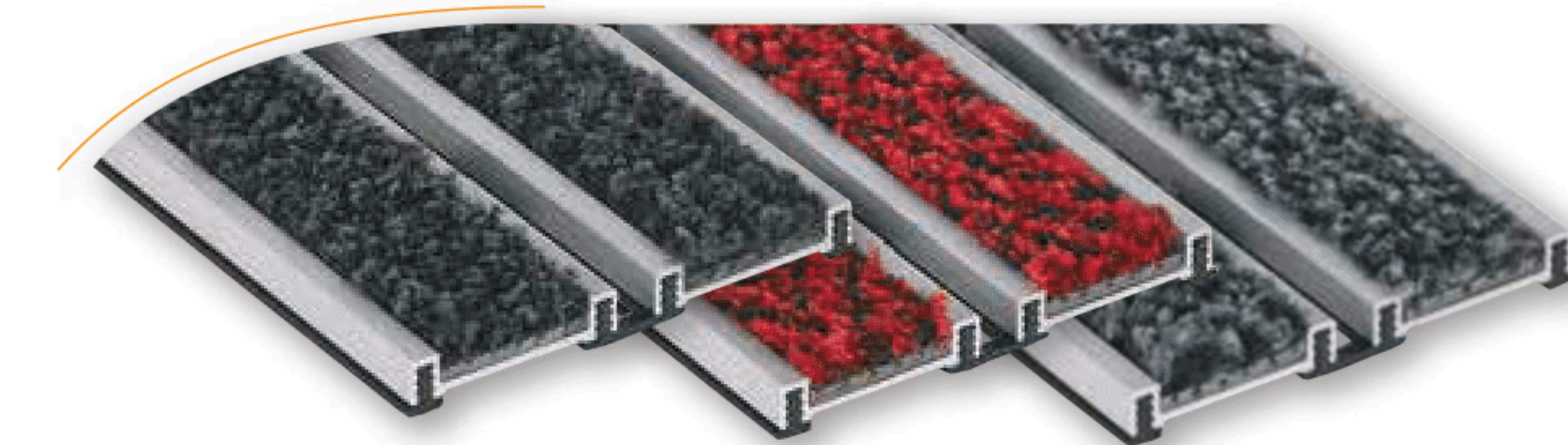

Reference	Loop pile coarse denier	Price excl. VAT/m <sup>2</sup>
8900	Anthracite	
8901	Light grey	
8903	Sisal shade	
8904	Red	



Reference	Tufted brush	Price excl. VAT/m <sup>2</sup>
8930	Dark grey	
8933*	Red	
8934	Grey	

\* End-of-life product, could be withdrawn during the course of the year.



Reference	Material	Price excl. VAT/m <sup>2</sup>
8950	Fluted rubber Black	
8445	Rubber + carpet* combined	

\* Carpet type to be specified

### ACCESSORY FOR ROMAT

Reference	Designation	Spec.	Price excl. VAT
6109*	Set of 4 junction clips	To link mat units so that their profiles are well aligned on the whole mat length. To be installed every 60 or 70 cm.	

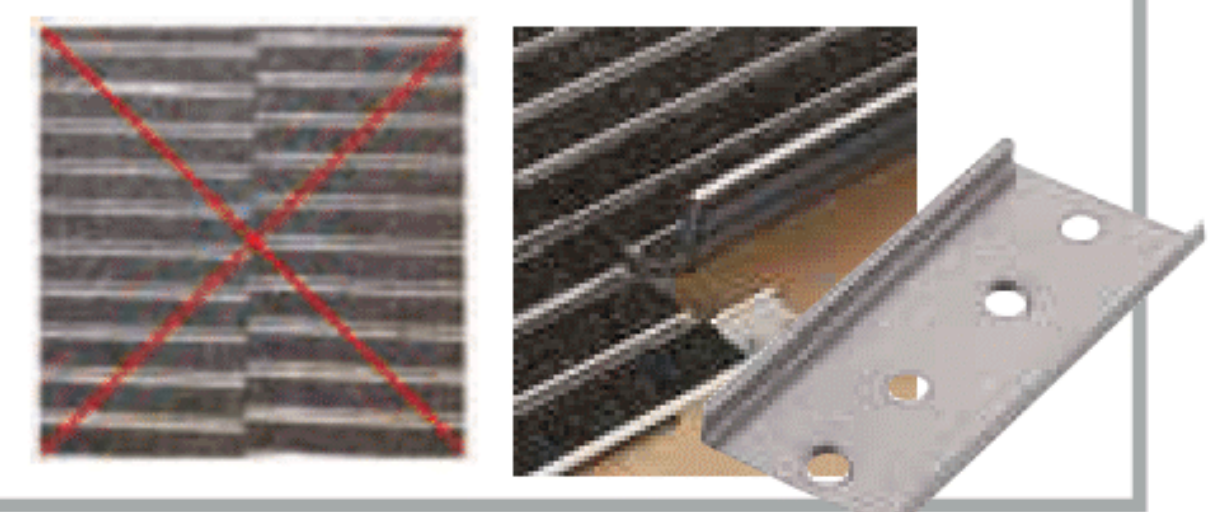

\* End-of-life product, could be withdrawn during the course of the year.



## ROMAT

### ROMAT 17 MM

Price / m<sup>2</sup>

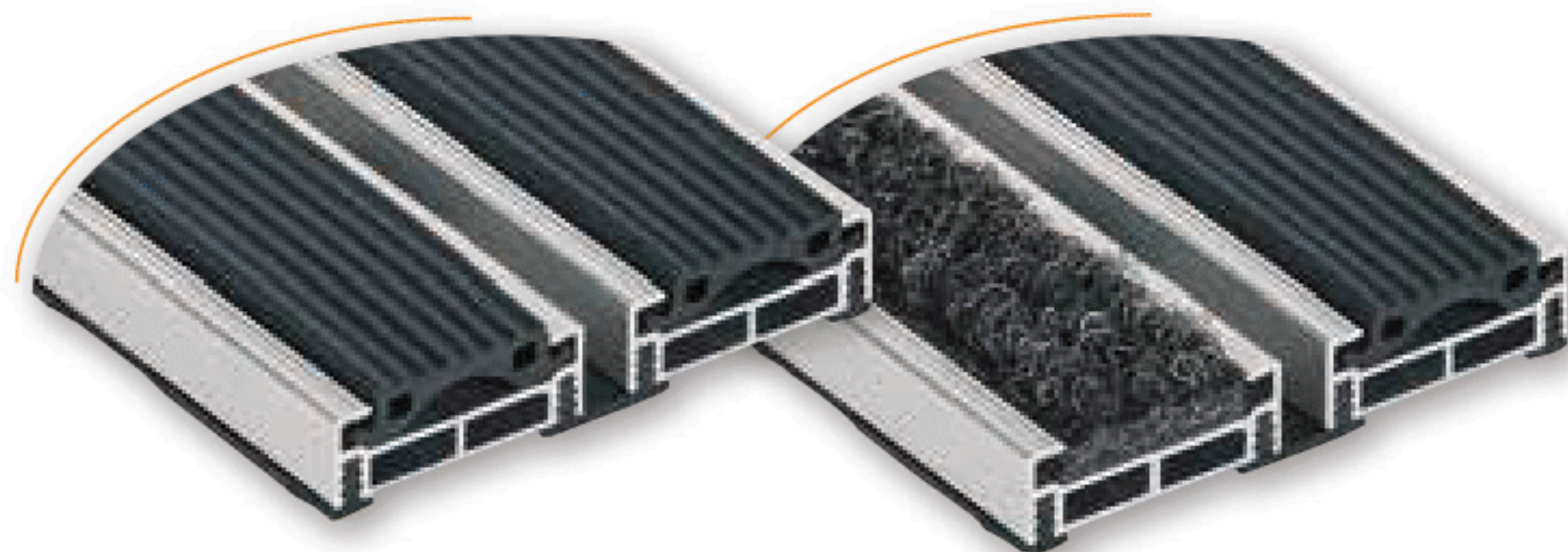
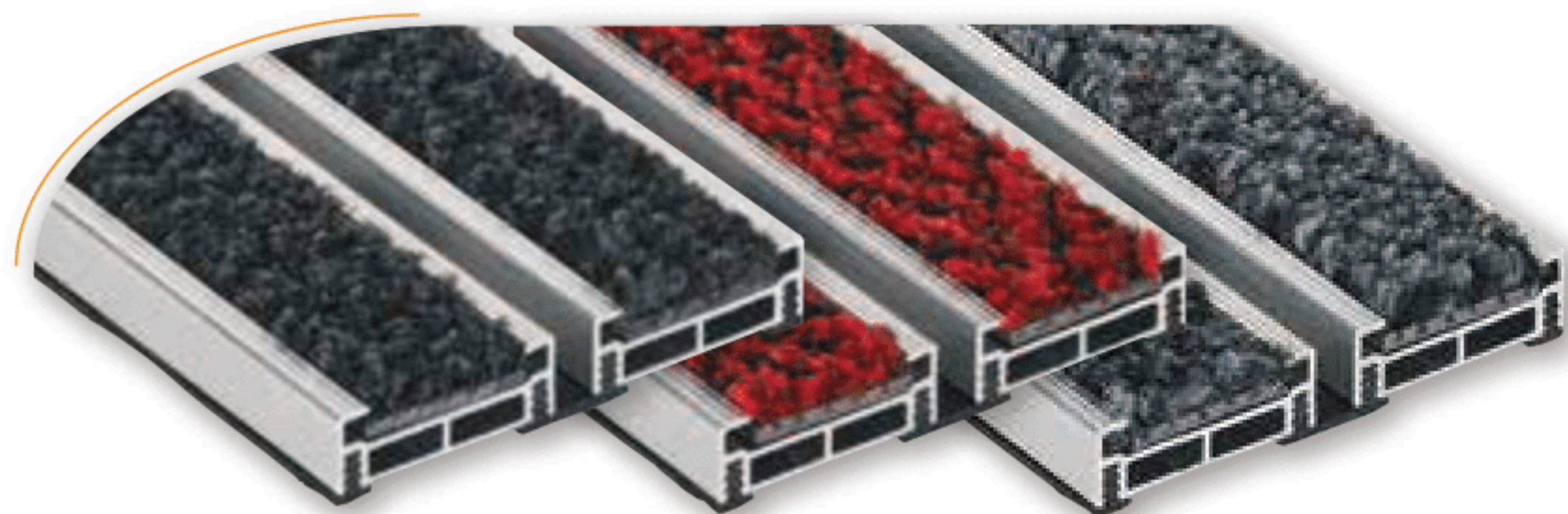
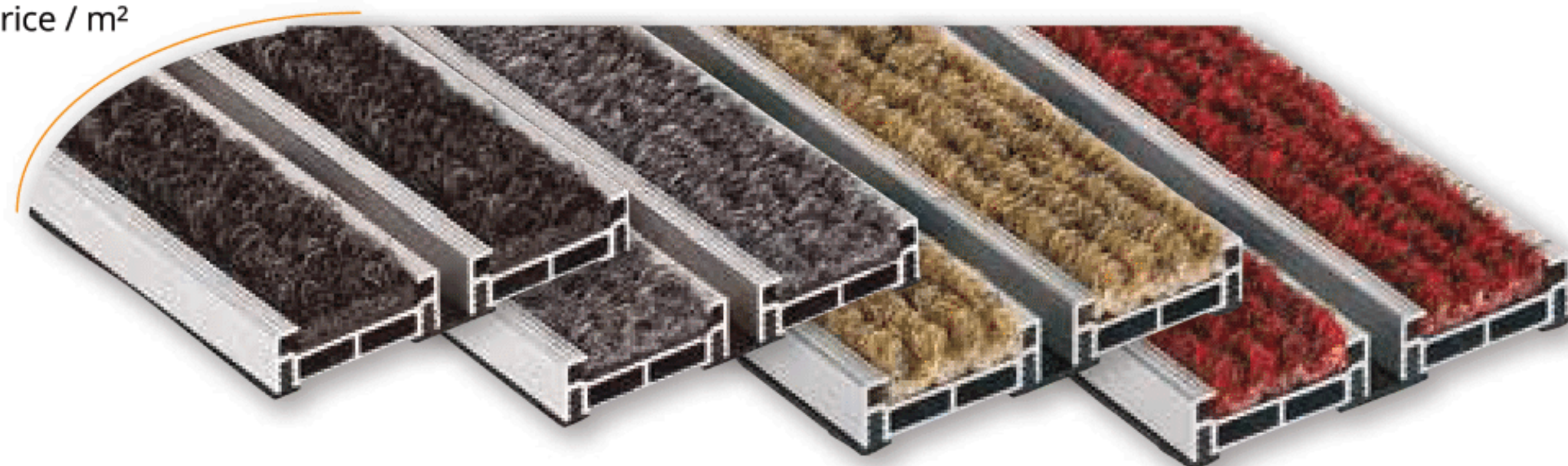

AREA 2	Reference	Loop pile Coarse denier	Price excl. VAT/m <sup>2</sup>
	8910	Anthracite	
	8911	Light grey	
	8913	Sisal shade	
	8914	Red	

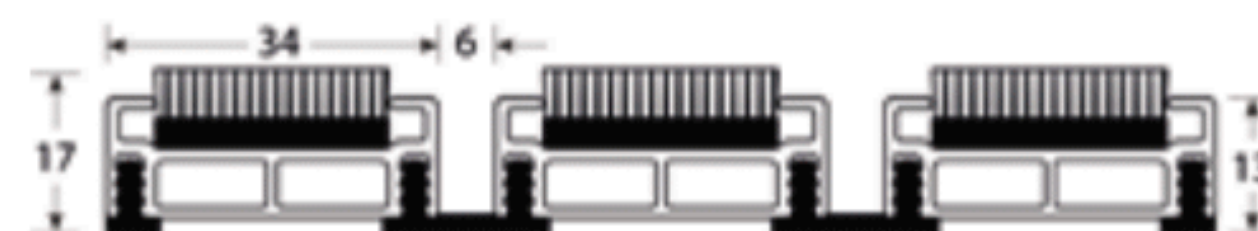

AREA 2	Reference	Tufted brush	Price excl. VAT/m <sup>2</sup>
	8940	Dark grey	
	8943	Red*	
	8944	Grey	

\* End-of-life product, could be withdrawn during the course of the year.



AREA 1	Reference	Material	Price excl. VAT/m <sup>2</sup>
	8951	Fluted rubber Black	
AREA 2	8446	Rubber + carpet* combined	

\* Carpet type to be specified

### ROMAT 22 MM

Price / m<sup>2</sup>

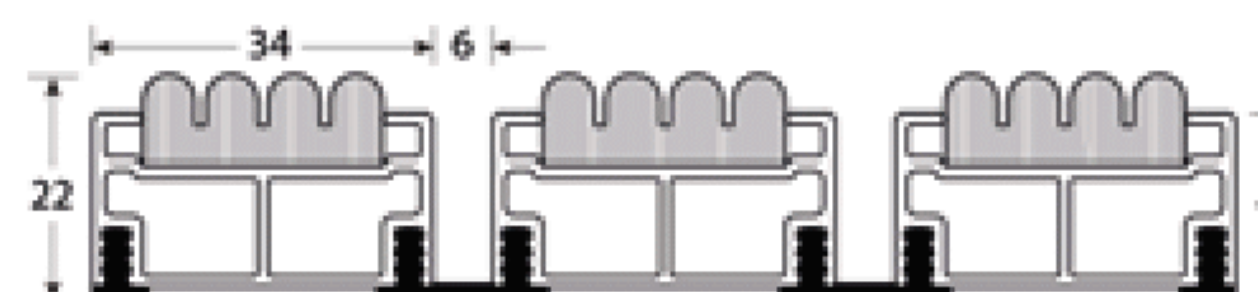
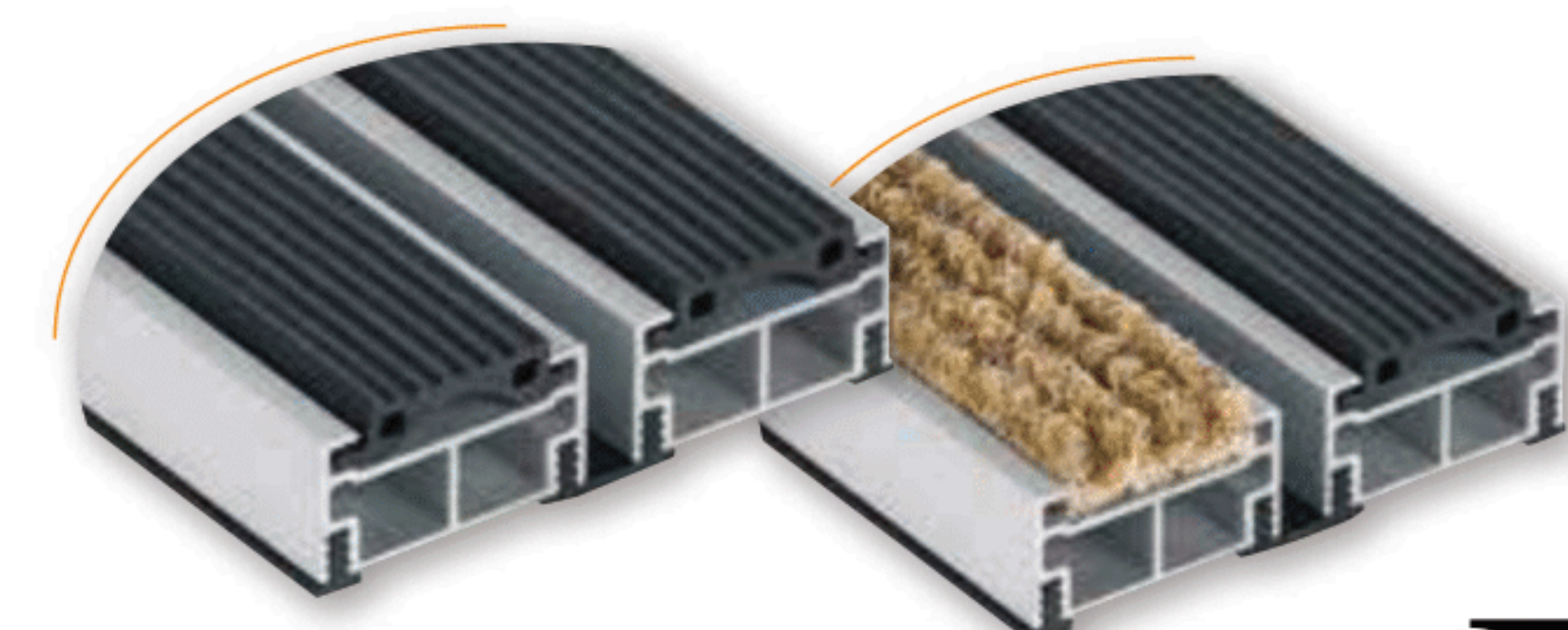
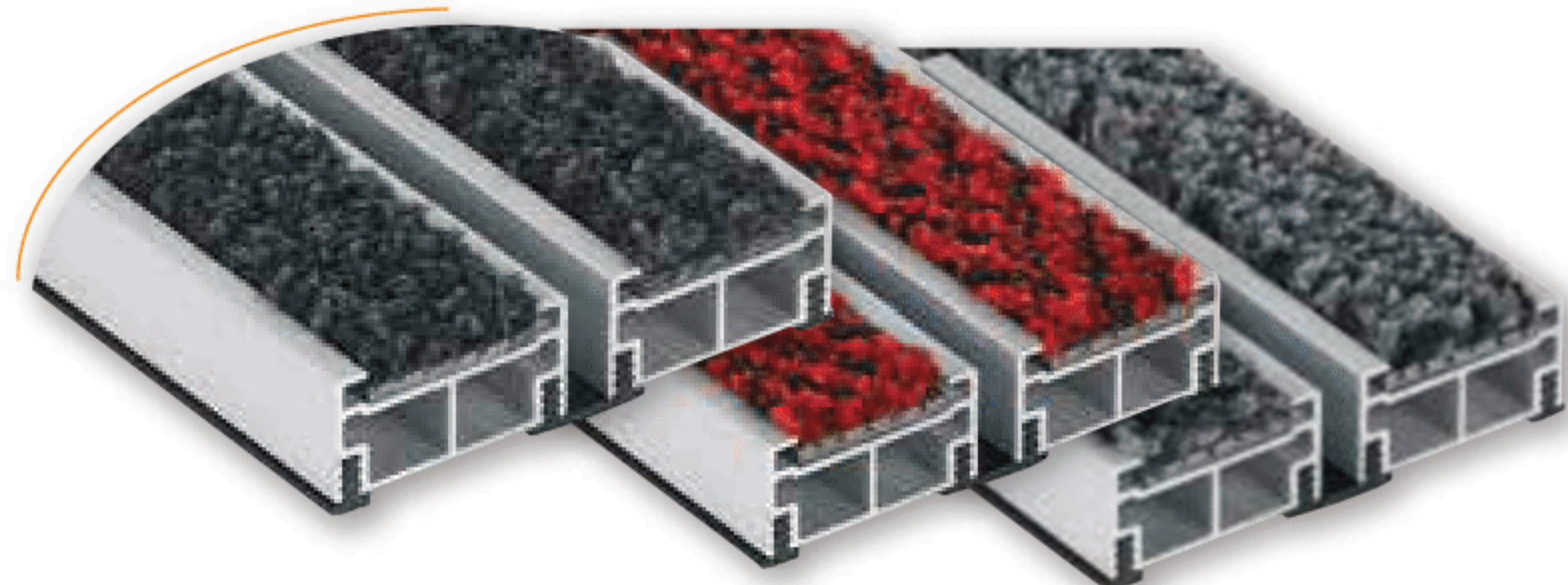
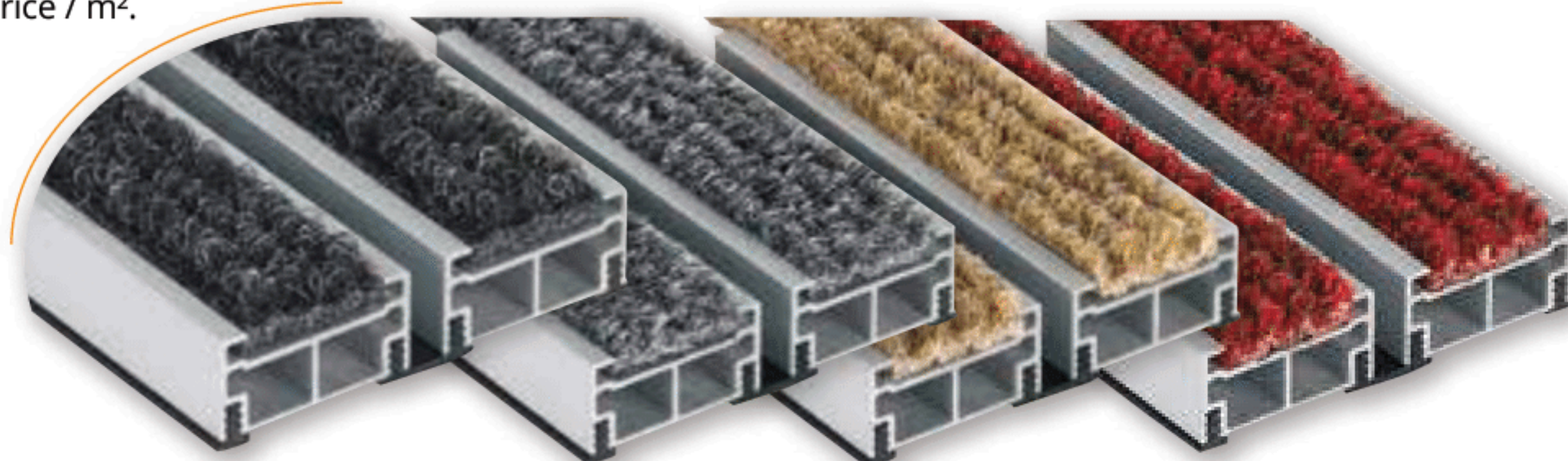

AREA 2	Reference	Loop pile Coarse denier	Price excl. VAT/m <sup>2</sup>
	8920	Anthracite	
	8921	Light grey	
	8923	Sisal shade	
	8924	Red	

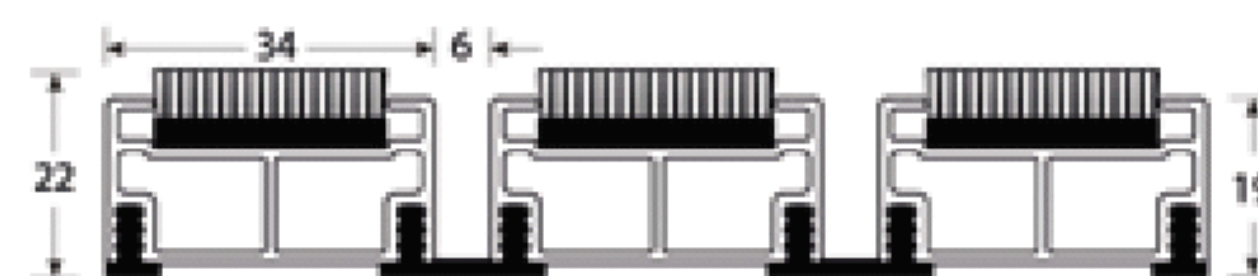

AREA 2	Reference	Tufted brush	Price excl. VAT/m <sup>2</sup>
	8970	Dark grey	
	8972*	Red	
	8973	Grey	

\* End-of-life product, could be withdrawn during the course of the year.



AREA 1	Reference	Material	Price excl. VAT/m <sup>2</sup>
	8952	Fluted rubber Black	
AREA 2	8447	Rubber + carpet* combined	

\* Carpet type to be specified

**!** Order form on p.219



## ROMAT GT



Profiles linked together with a cable



### ► CONSTRUCTION:

ROMAT GT matting was designed for indoor or covered outdoor surfaces and for heavy foot traffic. It is made of heavy duty dust barrier carpet strips (some of which with fire rating) inserted in mill aluminium profile sections. These sections are linked together with a galvanised steel cable and fixed with zinc plated screws and bolts. Rubber spacers ensure 4 to 6 mm between each section. Traffic noise is deadened by anti-slip rubber strips glued under each aluminium section.

**Thickness of profiles: 1.5 mm**

### ► MAINTENANCE:

Dirt passes between the profiles and falls into the matwell. The mat can easily be rolled up for regular vacuuming, over the mat and underneath.

**Rolls up / attractive and decorative / made to measure**

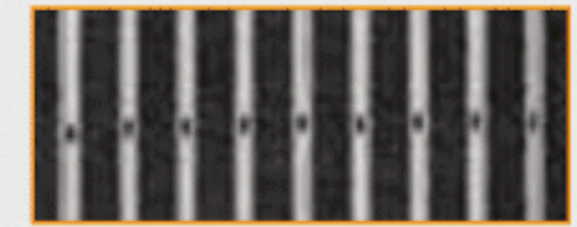

EXT  
Area 1

INT  
Area 2

High

Average  
(100 kg)

Bfl-s1

ROLL-UP

Open

12 mm  
thickness

17 mm  
thickness

22 mm  
thickness

#### 1 Loop pile Insert

100% polypropylene needle felt  
Scrapes / absorbs - Indoor

#### 2 Tufted Brush Insert

Tufted polyamide, giving an absorb-  
ing effect. Indoor

#### 3 Fluted rubber Insert

Black colour. Scrapes - Indoor /  
Outdoor (Covered places).

#### 4 Brush Insert

Nylon brushes 6.6 moulded in a  
PVC profile.  
Black colour. Scraper - Indoor/  
Outdoor.

## ROMAT GT - 12 MM

Price / m<sup>2</sup>

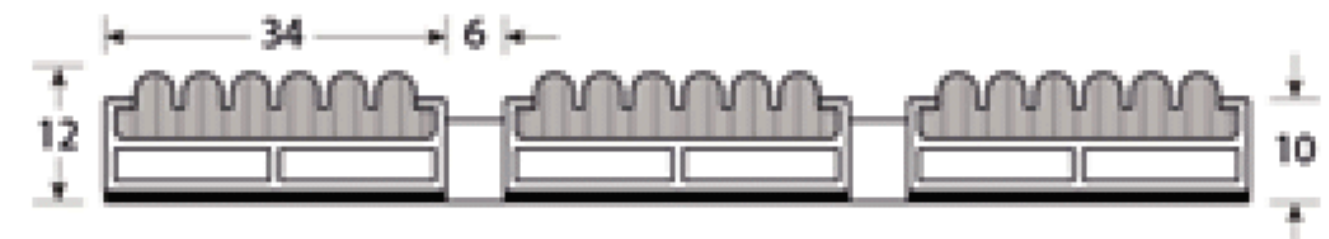
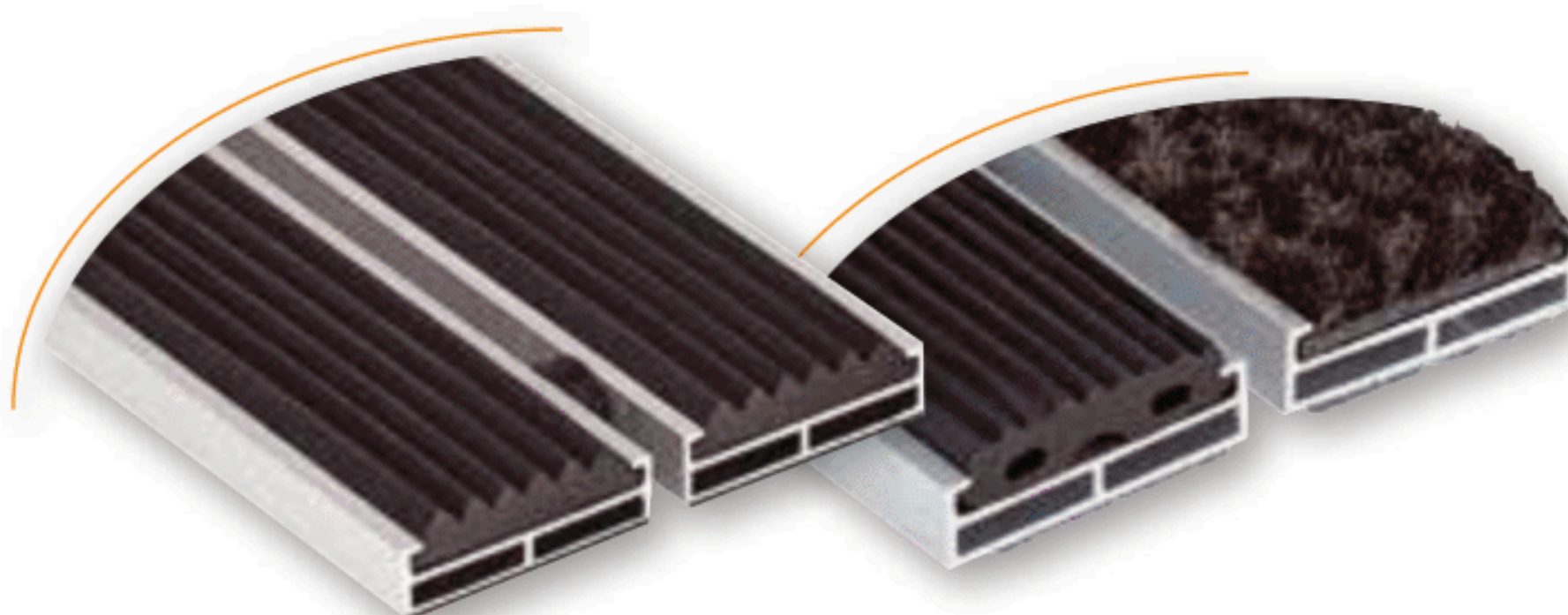
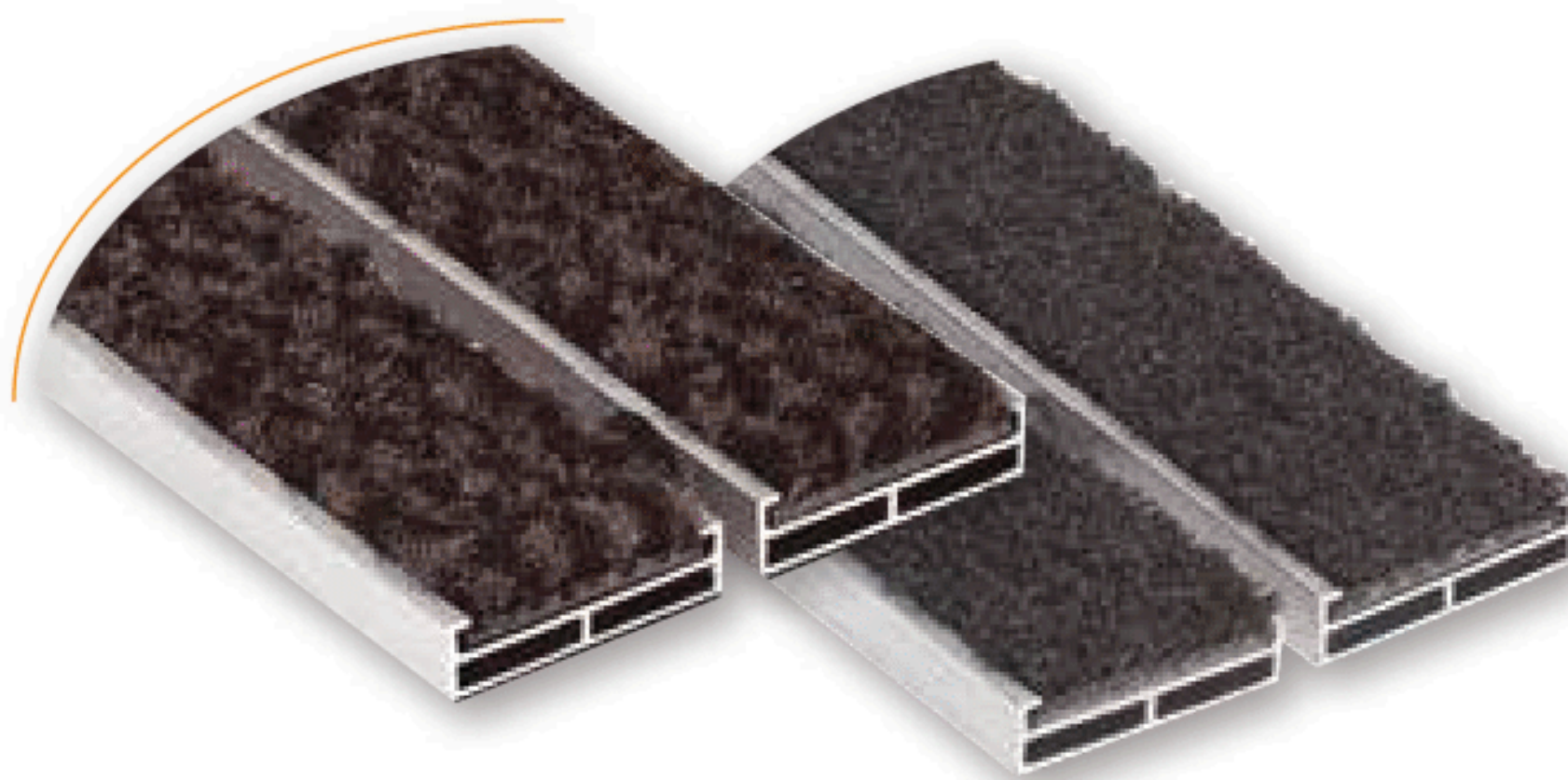
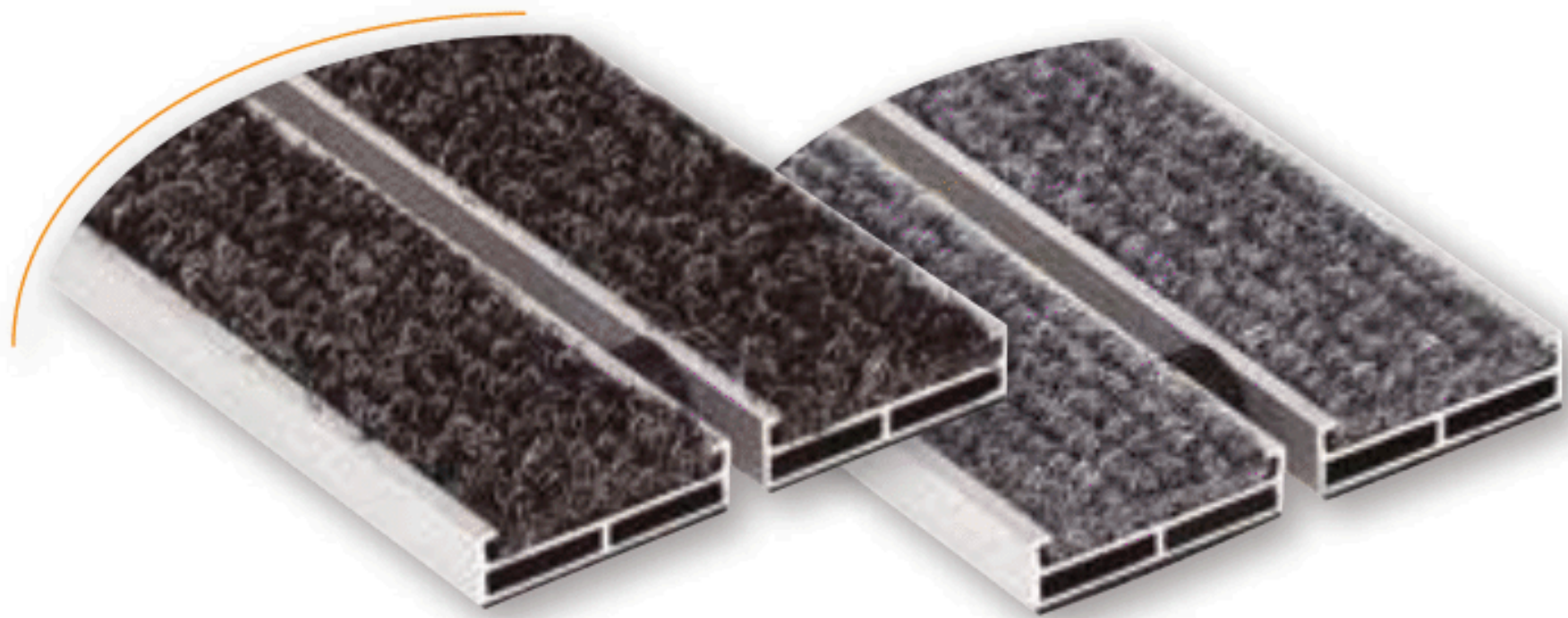

AREA 2	Reference	Loop pile Fine denier	Price excl. VAT/m <sup>2</sup>
	8450	Anthracite	
	8451	Light grey	

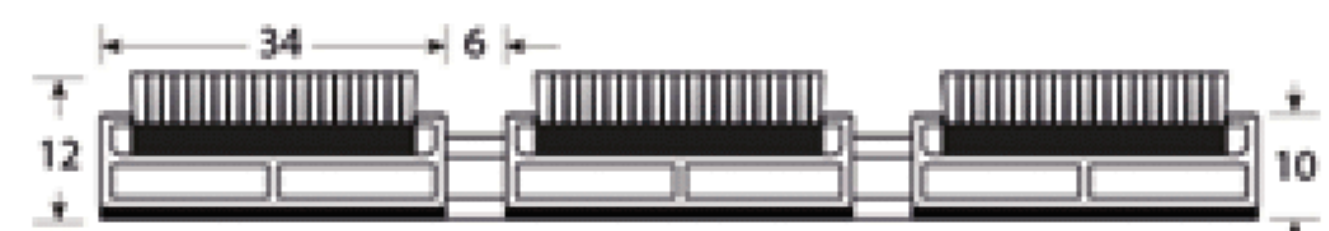

AREA 2	Reference	Tufted brush	Price excl. VAT/m <sup>2</sup>
	8430	Anthracite speckled	
	8432	Black	



AREA 1	Reference	Material	Price excl. VAT/m <sup>2</sup>
	8980	Fluted rubber Black**	
AREA 2	8440	Rubber + carpet* combined	

\* Carpet type to be specified  
\*\* Cfl-s1



ROMAT GT



**ROMAT GT - 17 MM**

Price / m<sup>2</sup>



AREA 2	Reference	Loop pile Coarse denier	Price excl. VAT/m <sup>2</sup>
	8460	Anthracite	
	8461	Light grey	
	8463	Sisal shade	



AREA 2	Reference	Tufted brush	Price excl. VAT/m <sup>2</sup>
	8480	Anthracite speckled	
	8484	Black	

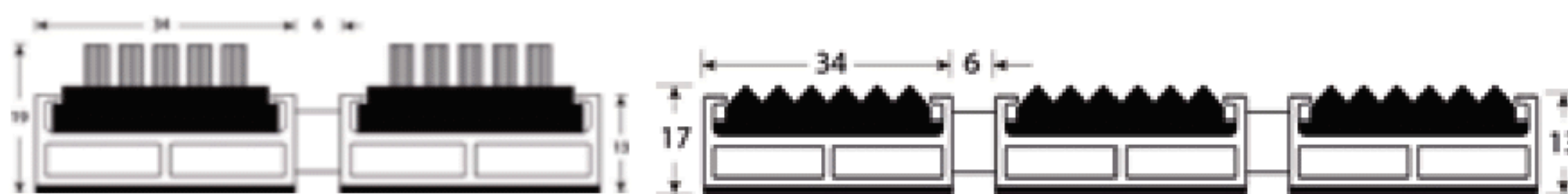

	Reference	Material	Price excl. VAT/m <sup>2</sup>
AREA 1	8981	Fluted rubber ** Black	
AREA 2	8441	Rubber + carpet* combined	
AREA 1	8438	Brush Black	

\* Carpet type to be specified \*\* Cfl-s1

**ROMAT GT - 22 MM**

Price / m<sup>2</sup>

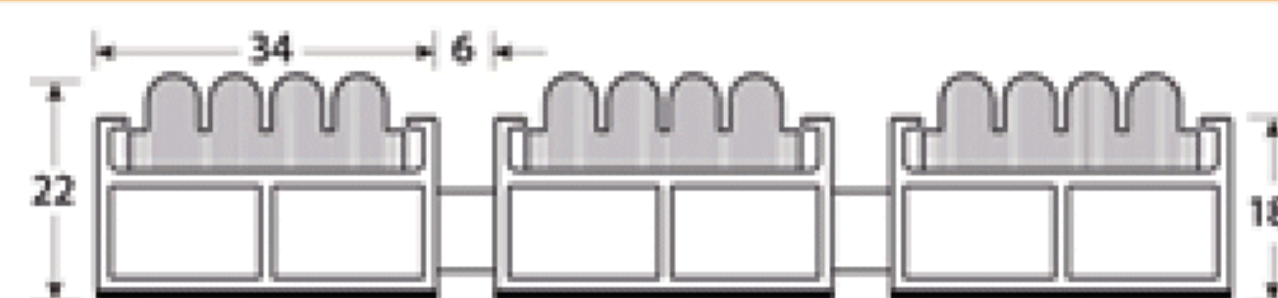

AREA 2	Reference	Loop pile Coarse denier	Price excl. VAT/m <sup>2</sup>
	8470	Anthracite	
	8471	Light grey	
	8473	Sisal shade	

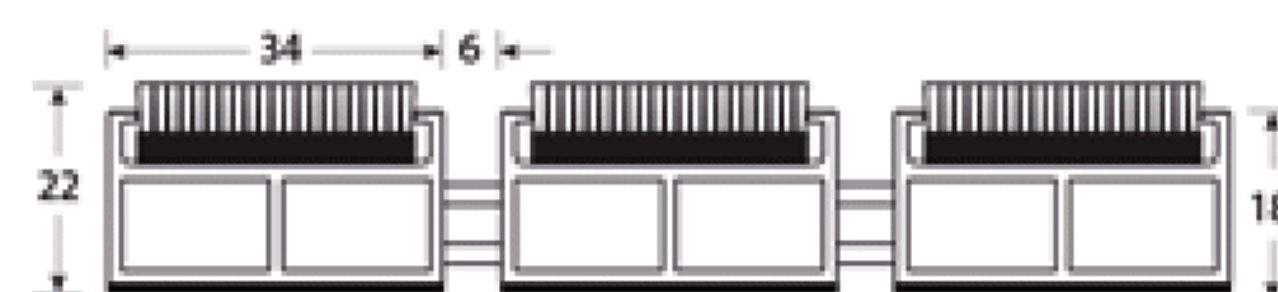

AREA 2	Reference	Tufted brush	Price excl. VAT/m <sup>2</sup>
	8490	Anthracite speckled	
	8494	Black	

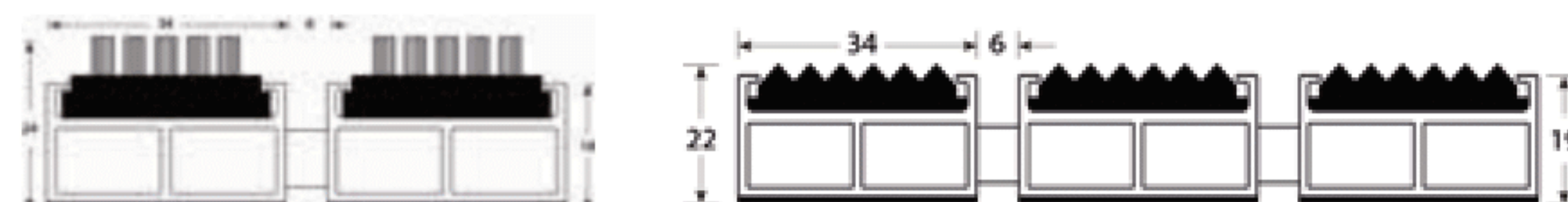

	Reference	Material	Price excl. VAT/m <sup>2</sup>
AREA 1	8982	Fluted rubber ** Black	
AREA 2	8442	Rubber + carpet* combined	
AREA 1	8439	Brush Black	

\* Carpet type to be specified \*\* Cfl-s1

**!** Order form on p.219



ROMAT GT-MAXX



Profiles linked together with a cable

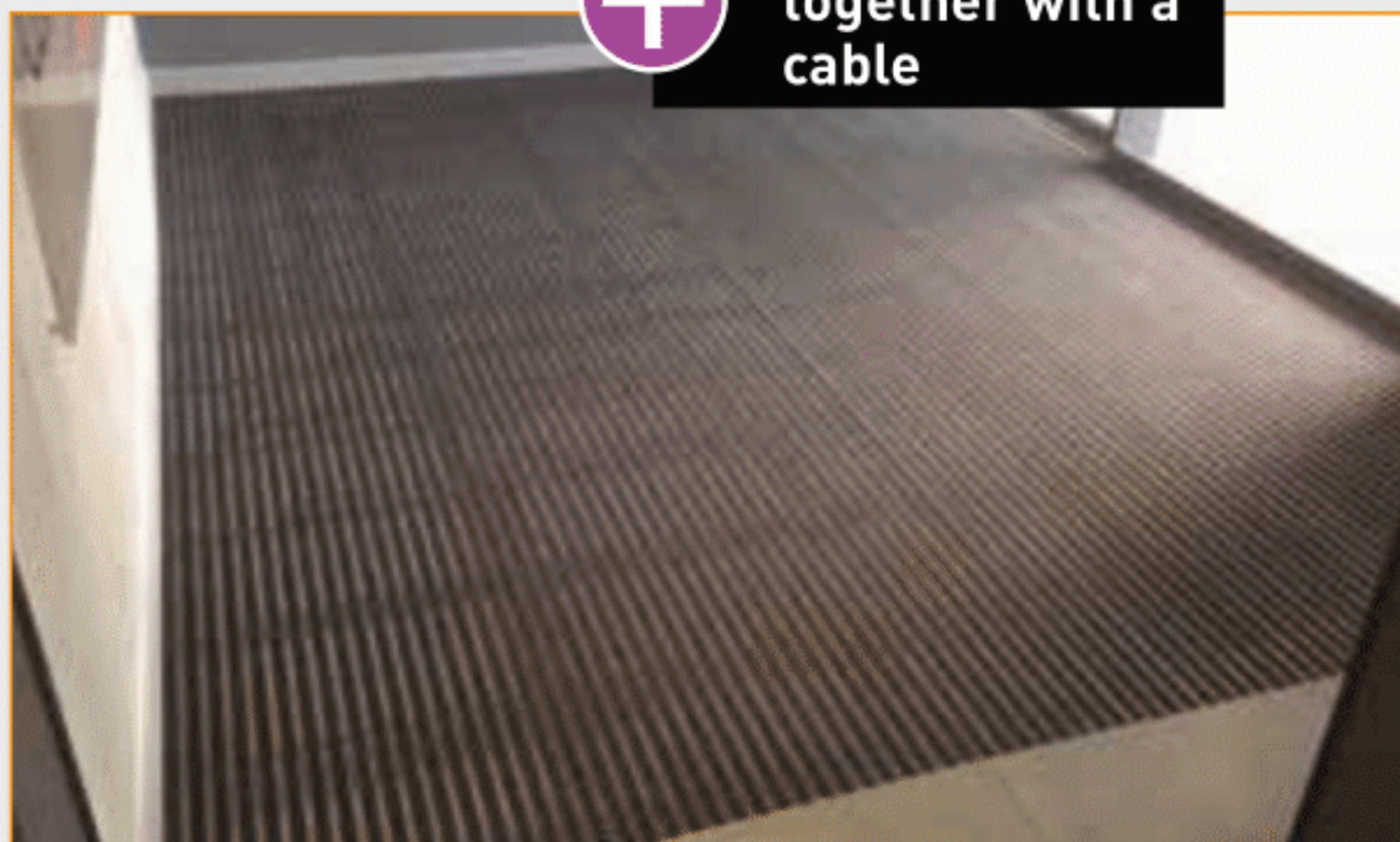

Rolls up / attractive and decorative / made to measure

► CONSTRUCTION :

The ROMAT MAXX mat is an entrance mat suitable for intensive traffic and heavy loads. Made of natural aluminium into which strips of specially designed anti-dirt carpet are inserted (some with fire classification). The profiles are linked to each other by a flexible galvanised metal cable and locked in place by screws and bolts zinc plated. 4 to 6 mm rubber washer spacers between the profiles. A rubber, non-slip, acoustic insulation strip is glued under each aluminium bar. **The important thickness of the aluminium profiles (2.5 mm) make it suitable for heavy traffic (max. 8000 kg /100 cm<sup>2</sup>).**

► MAINTENANCE :

The dirt passes between the profiles and is deposited in the matwell. The mat is very easily rolled up and both sides of the mat can be cleaned easily by frequent vacuum cleaning.

EXT Area 1 
 INT Area 2 
 High 
 Extreme (250 kg) 
 Bfl-s1 
 ROLL-UP 
 Open 
 22 mm thickness

**1 Loop pile Insert**  
100% polypropylene needle felt  
Scrapes / absorbs - Indoor

**2 Tufted Brush Insert**  
Tufted polyamide giving an absorbing effect. Indoor

**3 Fluted rubber Insert**  
Black colour. Scrapes - Indoor / Outdoor (covered places)

ROMAT GT-MAXX - 22 MM

Price / m<sup>2</sup>

High traffic Special for heavy loads

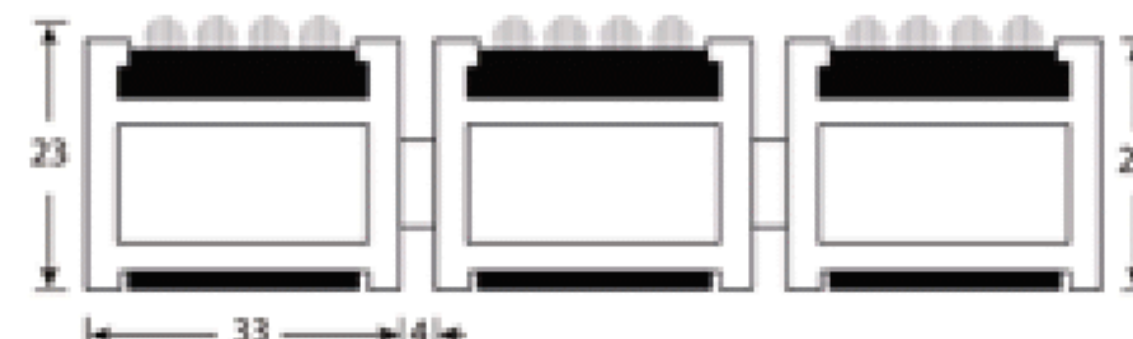
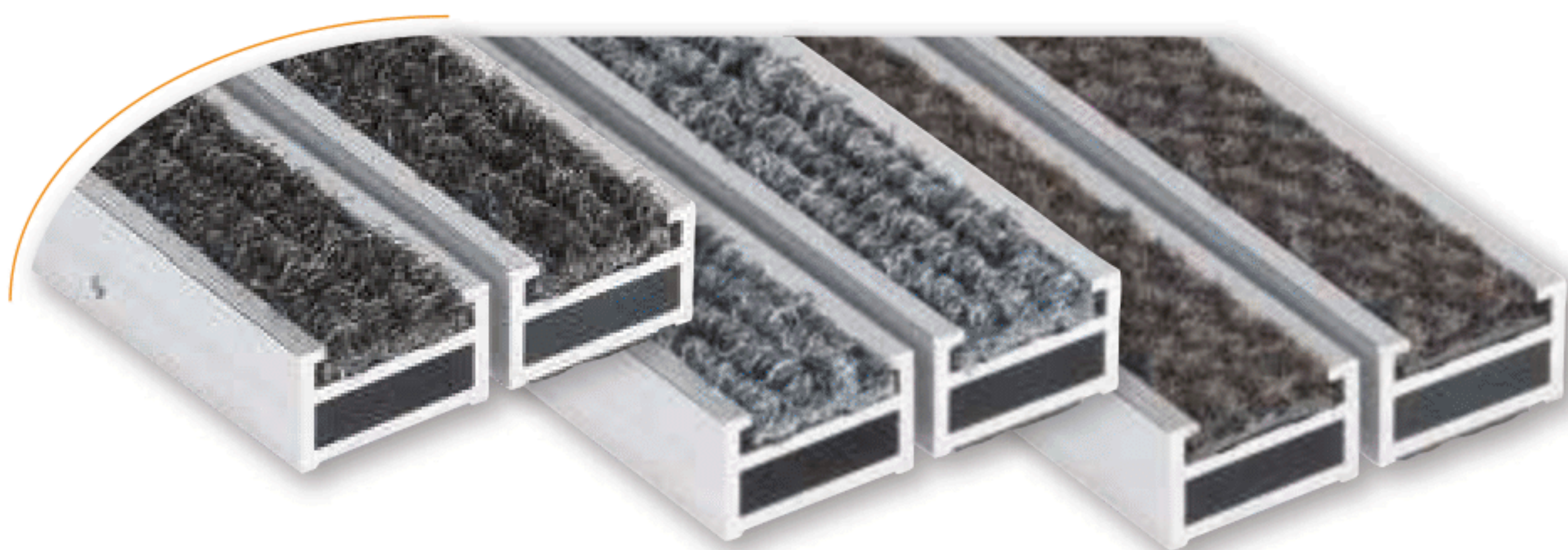

**AREA 2**

Reference	Loop pile Coarse denier	Price excl. VAT/m <sup>2</sup>
8990	Anthracite	
8991	Light grey	

**AREA 2**

Reference	Tufted brush	Price excl. VAT/m <sup>2</sup>
8994	Anthracite speckled	



ROMAT GT-XL

► CONSTRUCTION:

The ROMAT XL mat was designed for high foot traffic (up to 2,000 passages daily).

Made from unfinished aluminium profiles WIDER than on other mats (50 mm) in which dirt-resistant carpet tiles are inserted for indoors, or rubber inserts for outdoor use. Thanks to this insert width, the effectiveness of sole cleaning and the overall design of the entrance are significantly improved.

The profiles are linked to each other by a flexible galvanised metal cable and

locked in place by screws and zinc plated bolts. 4 to 6 mm rubber washer spacers between the profiles.

A non-slip rubber acoustic insulation strip is stuck under each aluminium bar. Thickness of profiles: 1.75 mm.

► MAINTENANCE :

The dirt passes between the profiles and is deposited in the matwell. The mat is very easily rolled up and both sides of the mat can be cleaned easily by frequent vacuum cleaning.

Rolls up / attractive and decorative / made to measure

EXT Area 1 
 INT Area 2 
 High 
 Average (100 kg) 
 Bfl-s1 
 ROLL-UP 
 Open 
 22 mm thickness

ROMAT GT-XL - 22 MM

Price / m<sup>2</sup>

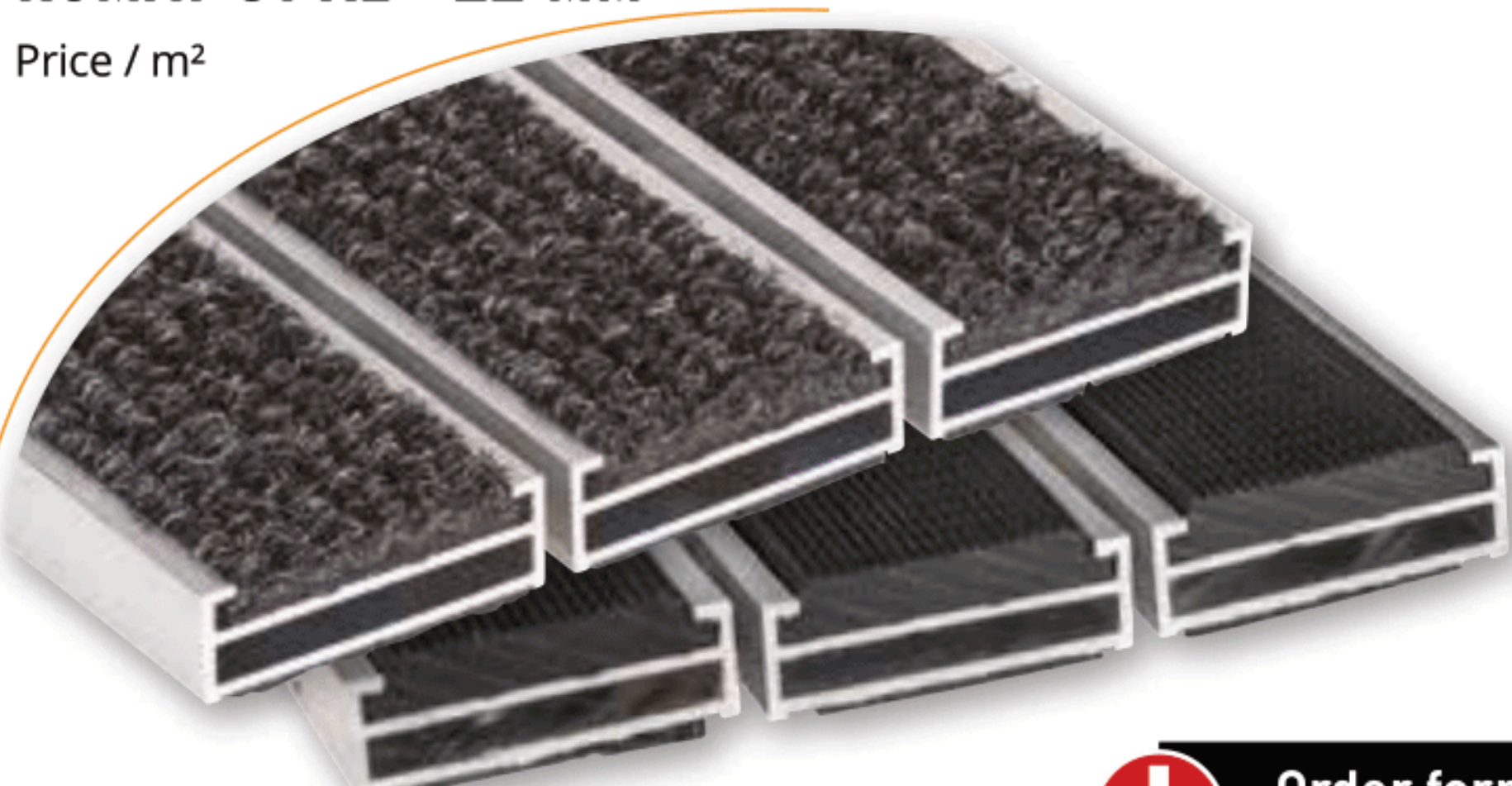

**1 Loop pile Insert**  
100% polypropylene needle felt  
Scrapes / absorbs - Indoor

**2 Fluted rubber Insert**  
Black colour. Scrapes - Indoor / Outdoor (covered places)

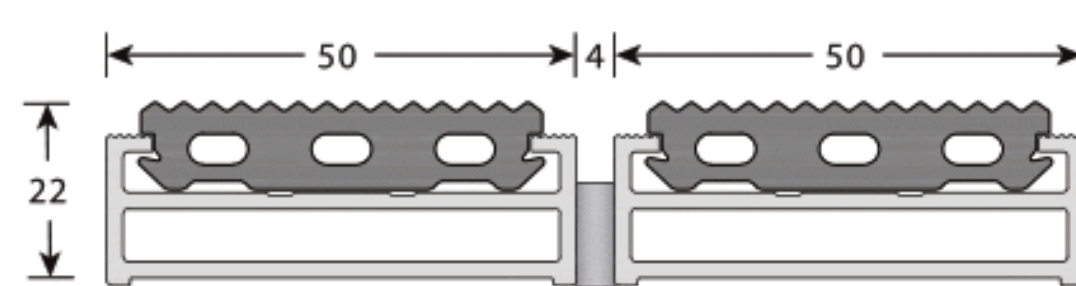
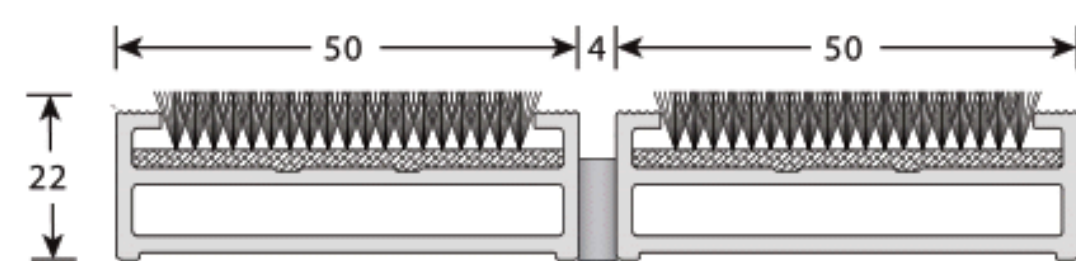

Reference	Material	Colours	Price excl. VAT/m <sup>2</sup>
<b>AREA 2</b> 8310	Loop pile Coarse denier	Anthracite	
<b>AREA 1</b> 8320	Fluted rubber	Black	

Order form on p.219

OPTION AVAILABLE

! 5 colours, contact us!

PROFILE ANODISATION

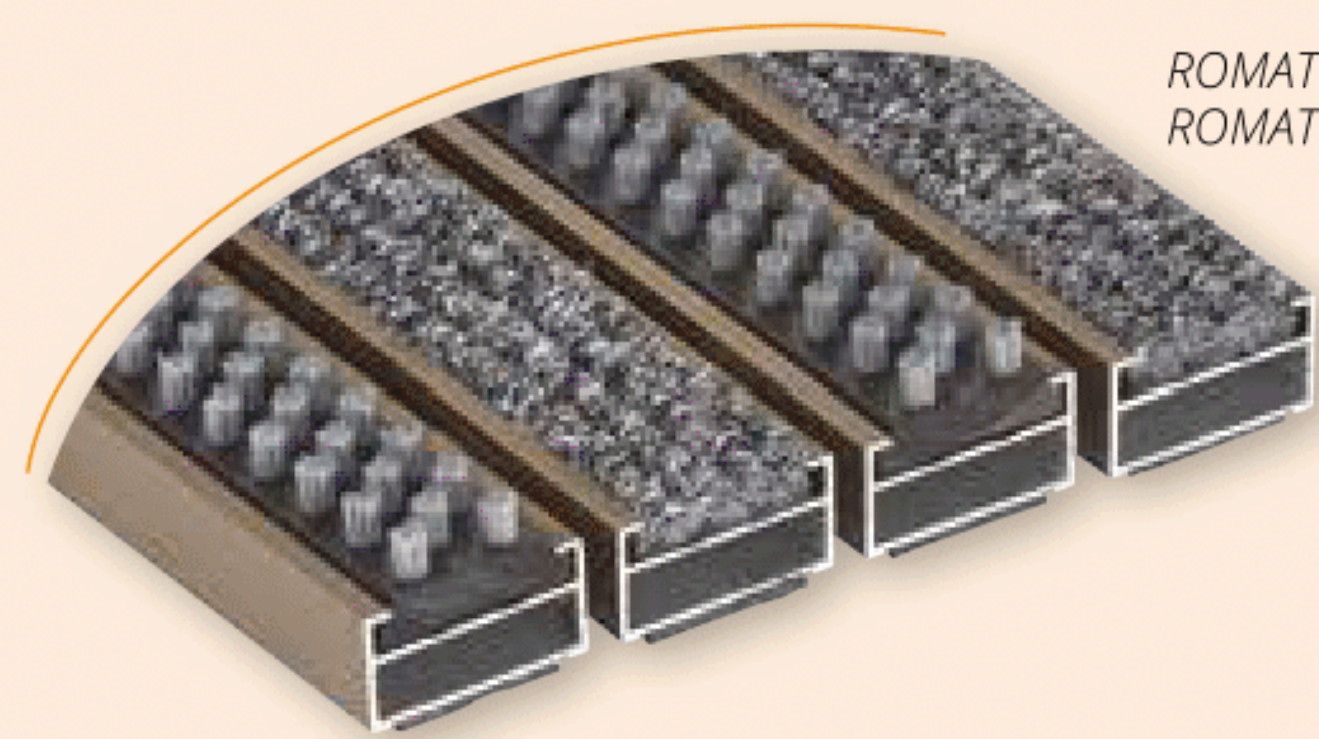

ROMAT GT/ROMAT XL/  
ROMAT MAXX

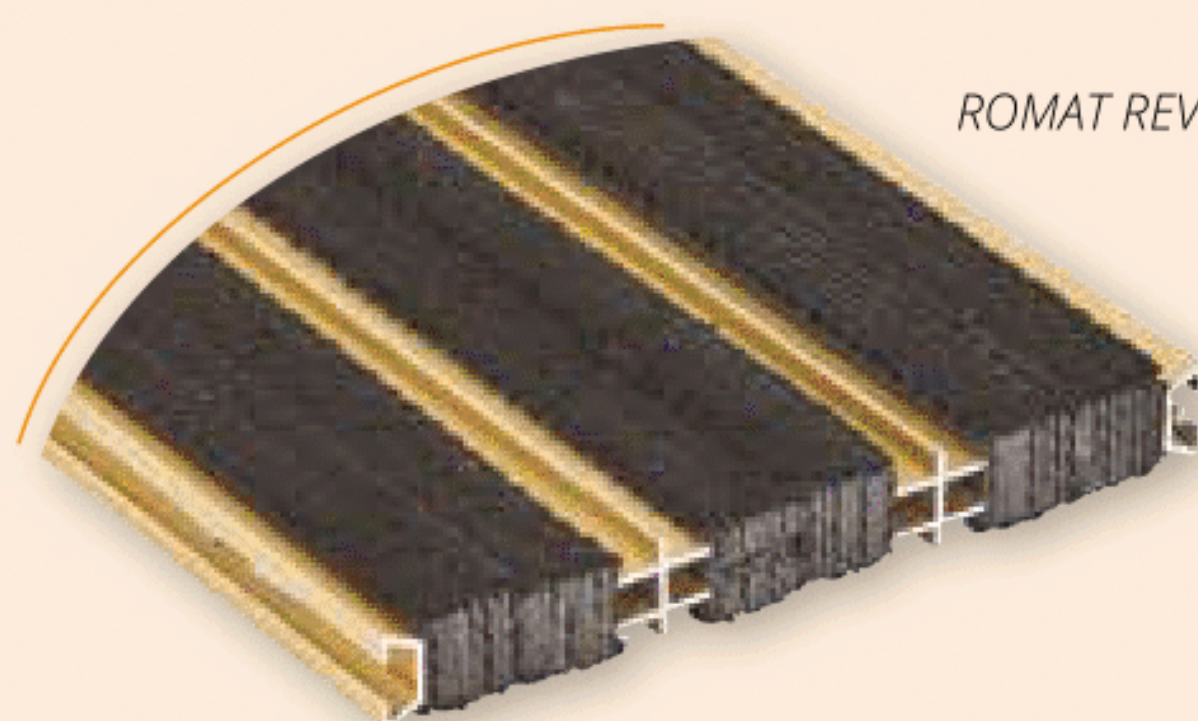

ROMAT REVERSIBLE

-  Natural aluminium
-  Alu gold 02
-  Alu gold 03
-  Titanium
-  Black

CUSTOMISED STAINLESS STEEL PROFILES

It is quite possible to add a welcome message, the name of a company, etc.... onto a stainless steel profile, which is then integrated into the mat between two profiles with insert. Capital letters are produced by laser cutting with a black background colour as standard, but also customisable (send us an RAL). This service can only be carried out on a ROMAT GT entrance matting, of any thickness.

To order a mat with a customised stainless steel profile:

- Place the order for the entrance matting using the order form (see p.219)
- Write the text to be included on the order form.
- Indicate the positioning of the profile on the entrance matting: in the middle, at the beginning or at the end of the mat.
- The entrance matting is billed normally according to its area.
- The profile is billed separately, per ml, with fixed production costs in addition.



Reference	Thickness	Material	Price excl. VAT
6212	ROMAT GT 12 mm	Stainless steel	
6217	ROMAT GT 17 mm	Stainless steel	
6222	ROMAT GT 22 mm	Stainless steel	

Reference		Price excl. VAT
6223	Fixed creation costs	

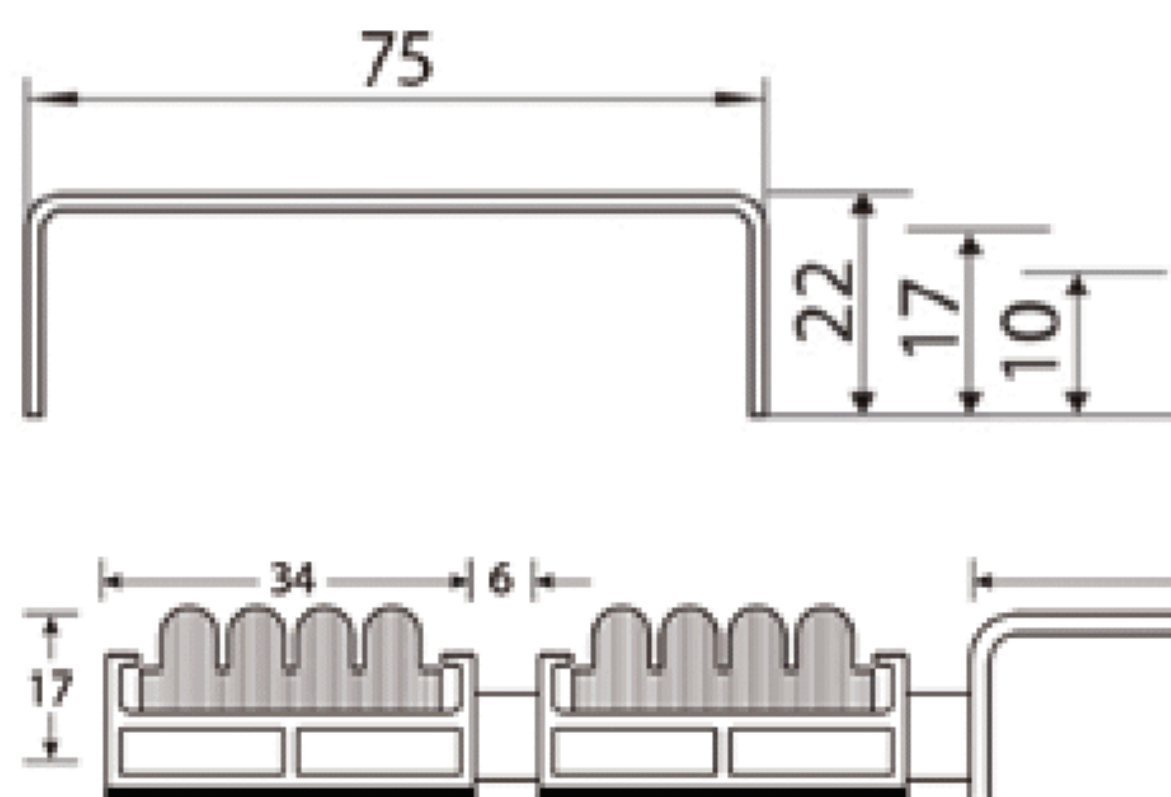

New

+ Incorporate text into your entrance mat

References

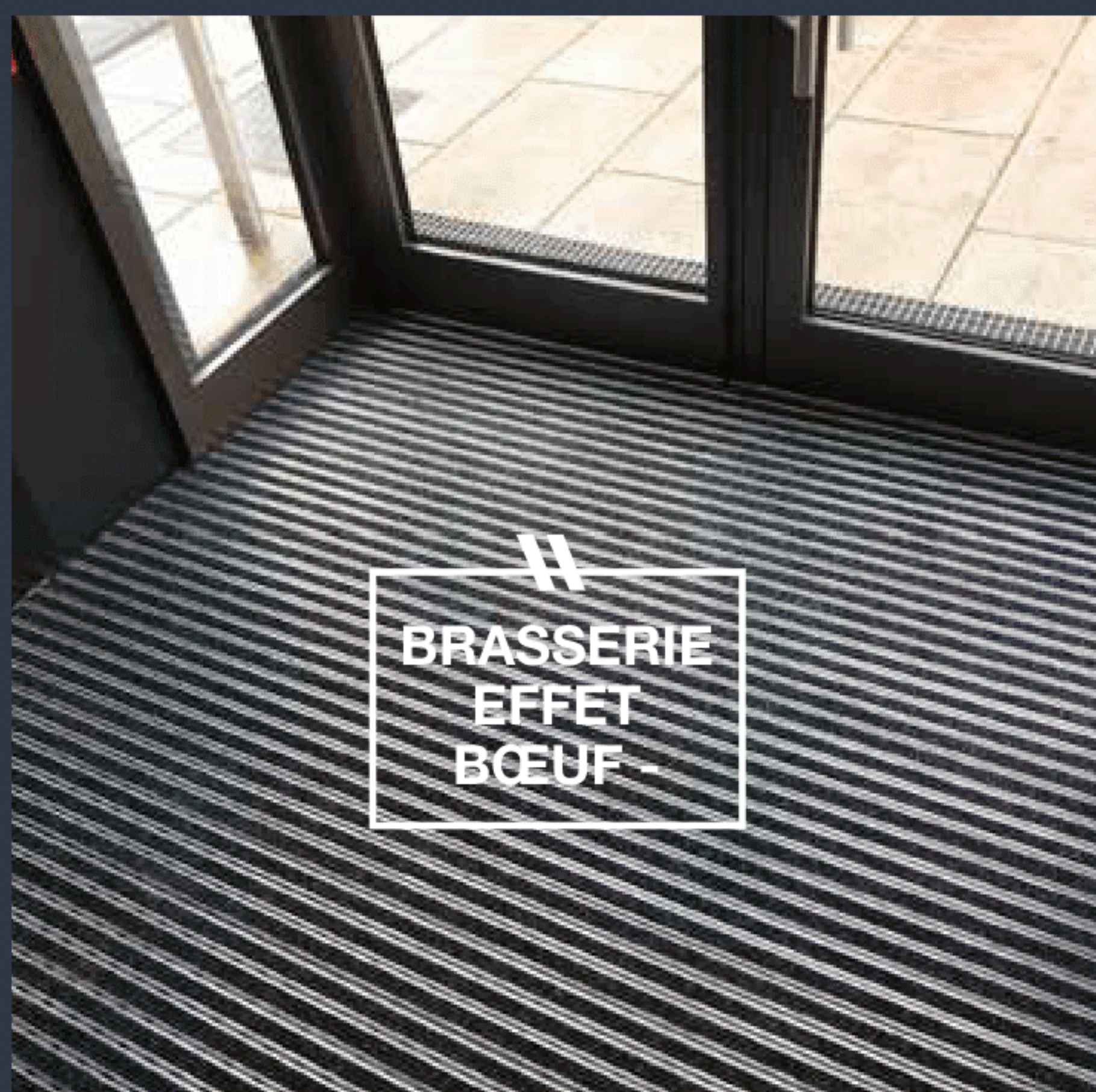

CHAMBERY



LAUSANNE- CH



ROMAT REVERSE





► CONSTRUCTION:

«ROMAT REVERSE» matting is made of inserts fitted between two mill aluminium profiles. The whole matting is assembled with galvanised steel rods.

► MAINTENANCE:

Dirt from shoes is removed by profile edges and falls between the absorbent inserts, allowing easy cleaning by vacuuming. Being reversible, these mats can also be turned regularly.

Insert	Rubber polyamide, buffed polyamide fibres (carpet effect)	Fluted rubber
Function	Scrapes - Absorbs (moisture from shoes) 	Scrapes 
Location	Indoor and covered spaces	Outdoor/Indoor
Traffic	Heavy traffic: including wheelchairs and trolleys	
Structure	Closed: Dirt retained on profiles	
	Open: dirt falls into the matwell	
Manufacturing	Made to measure	

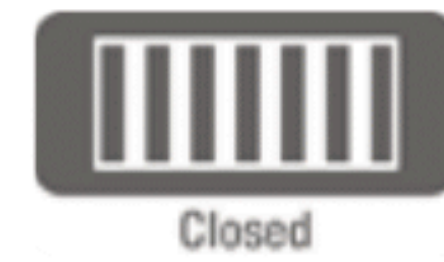

ROMAT REVERSE 12 MM

Price per m<sup>2</sup>

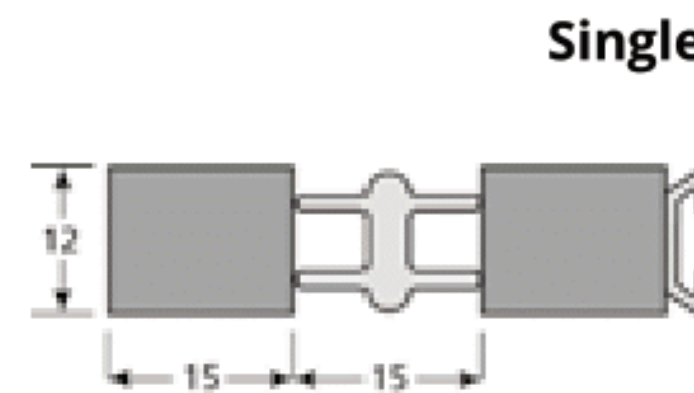
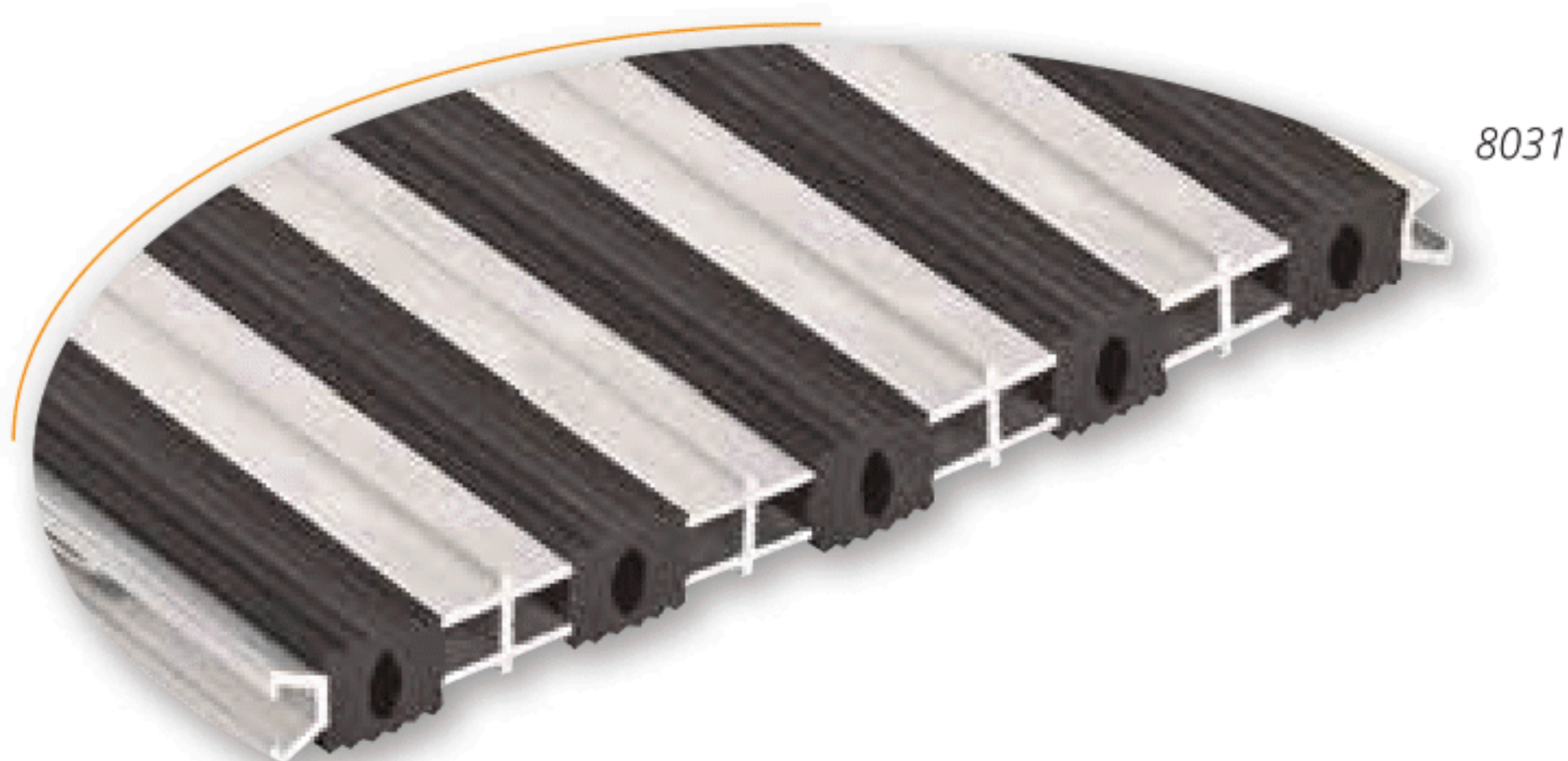
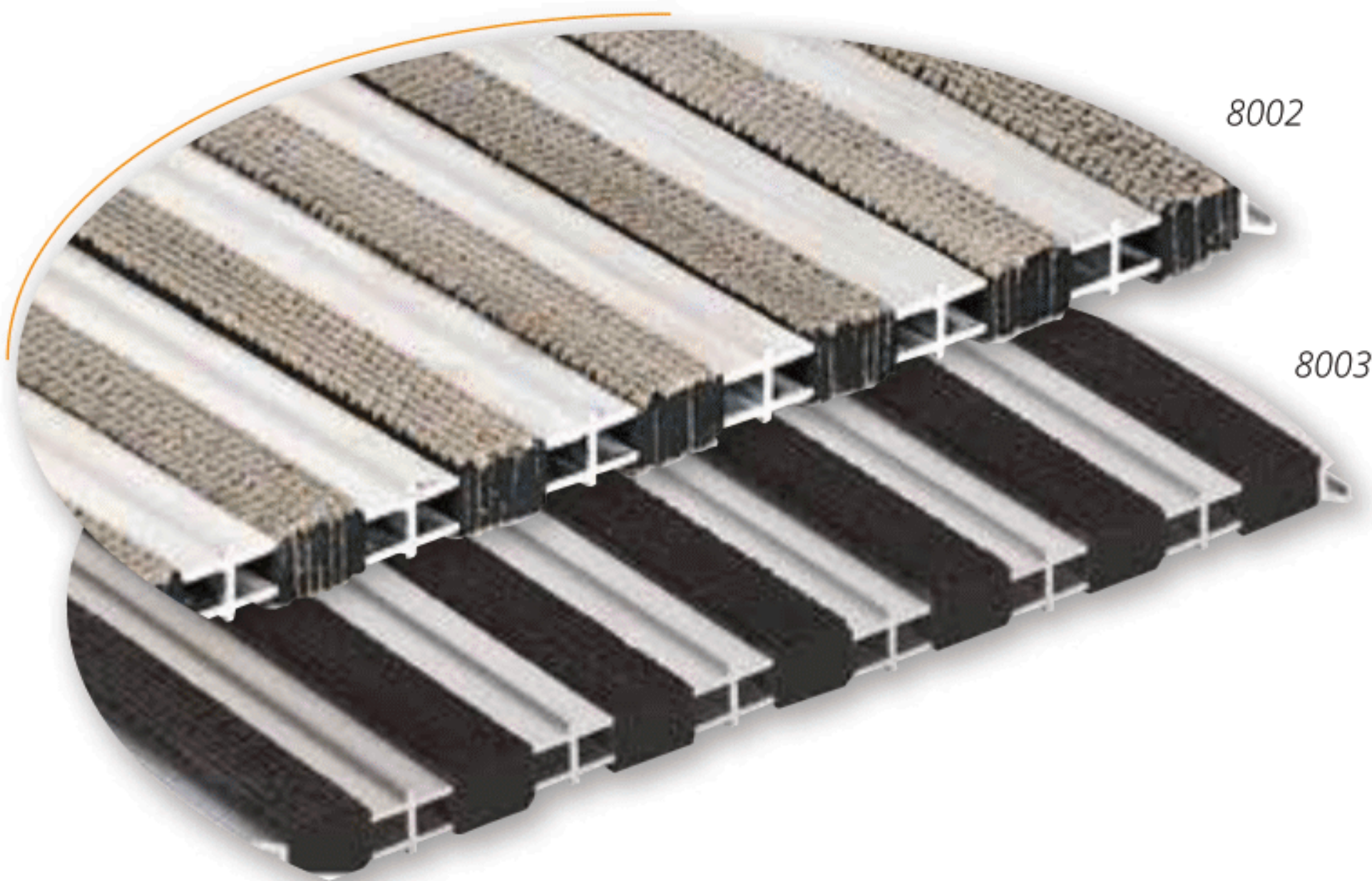

AREA 2

Reference	Material	Colours	Price excl. VAT/m <sup>2</sup>
8002	Polyamide	Grey	
8003	Rubber closed	Black	



AREA 1

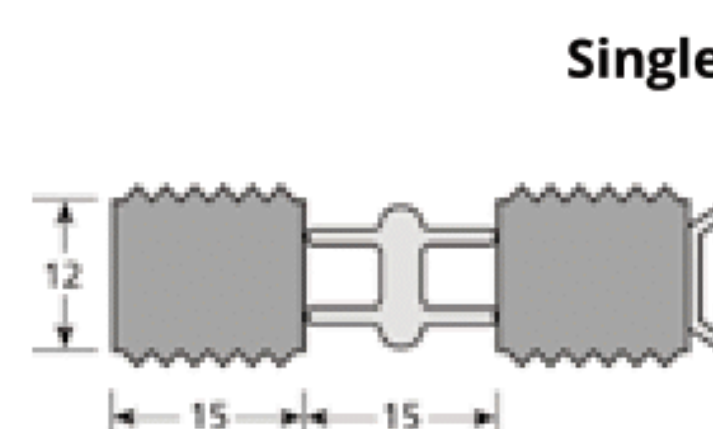

Reference	Material	Colours	Price excl. VAT/m <sup>2</sup>
8031	Fluted rubber closed	Black	



ROMAT REVERSE



ROMAT REVERSE 18 MM

Price per m<sup>2</sup>

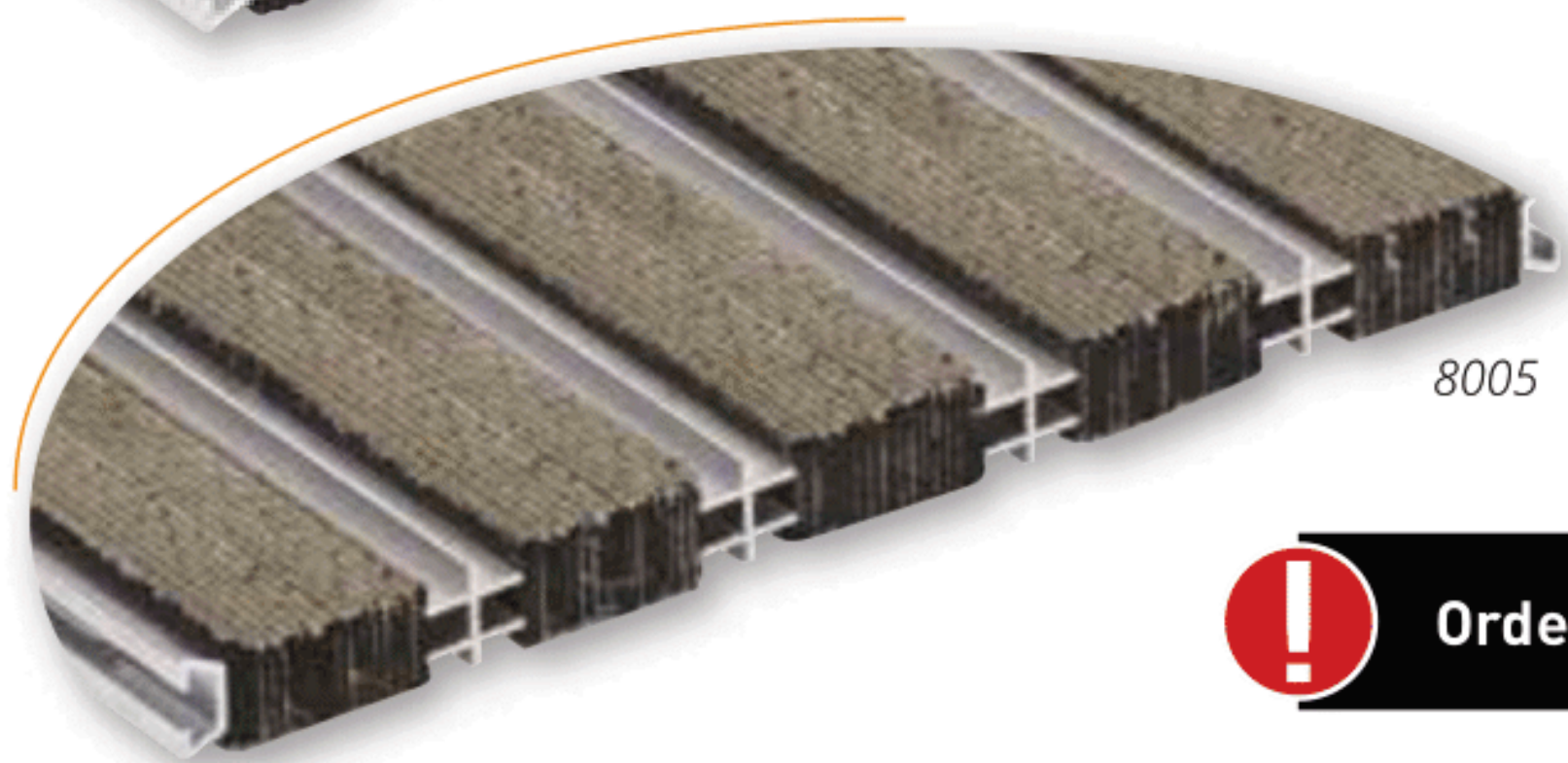
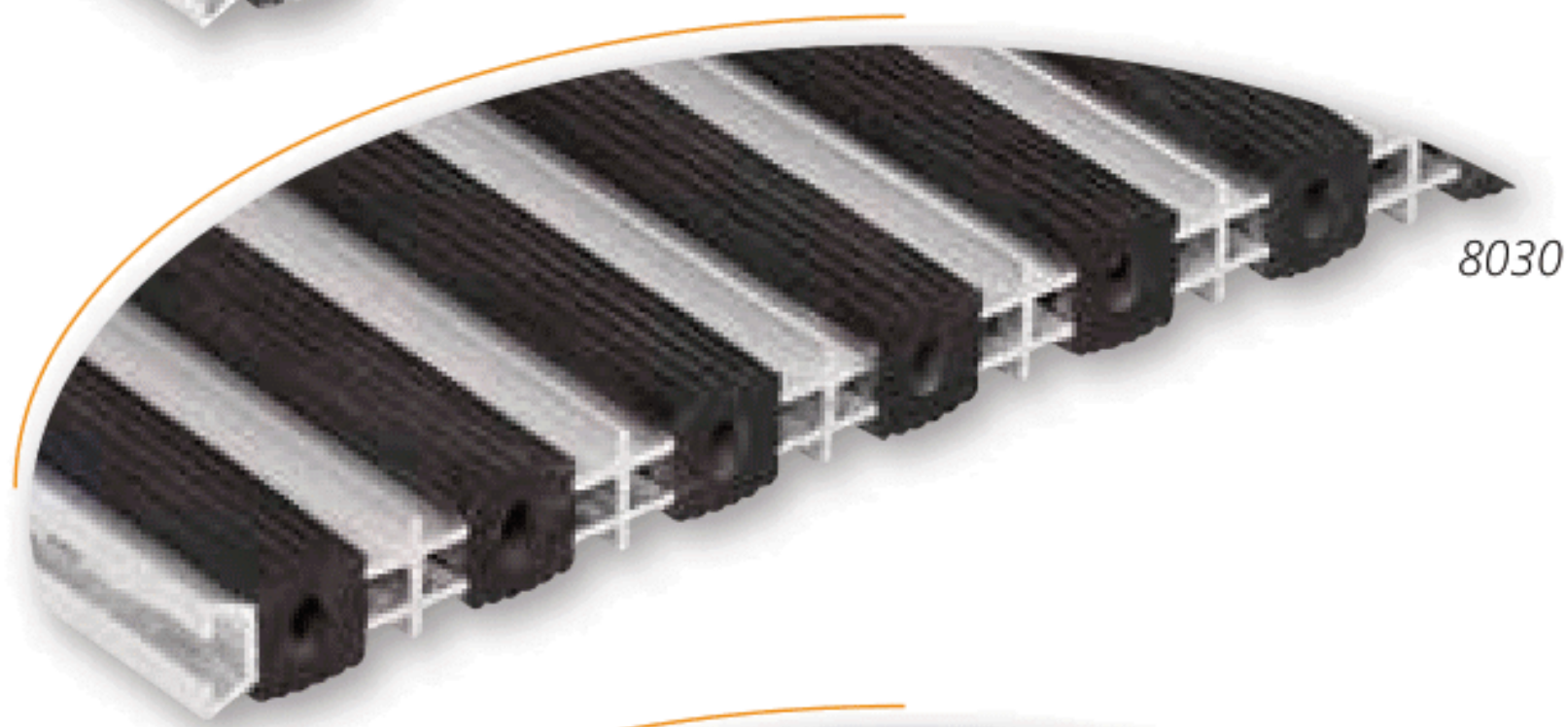
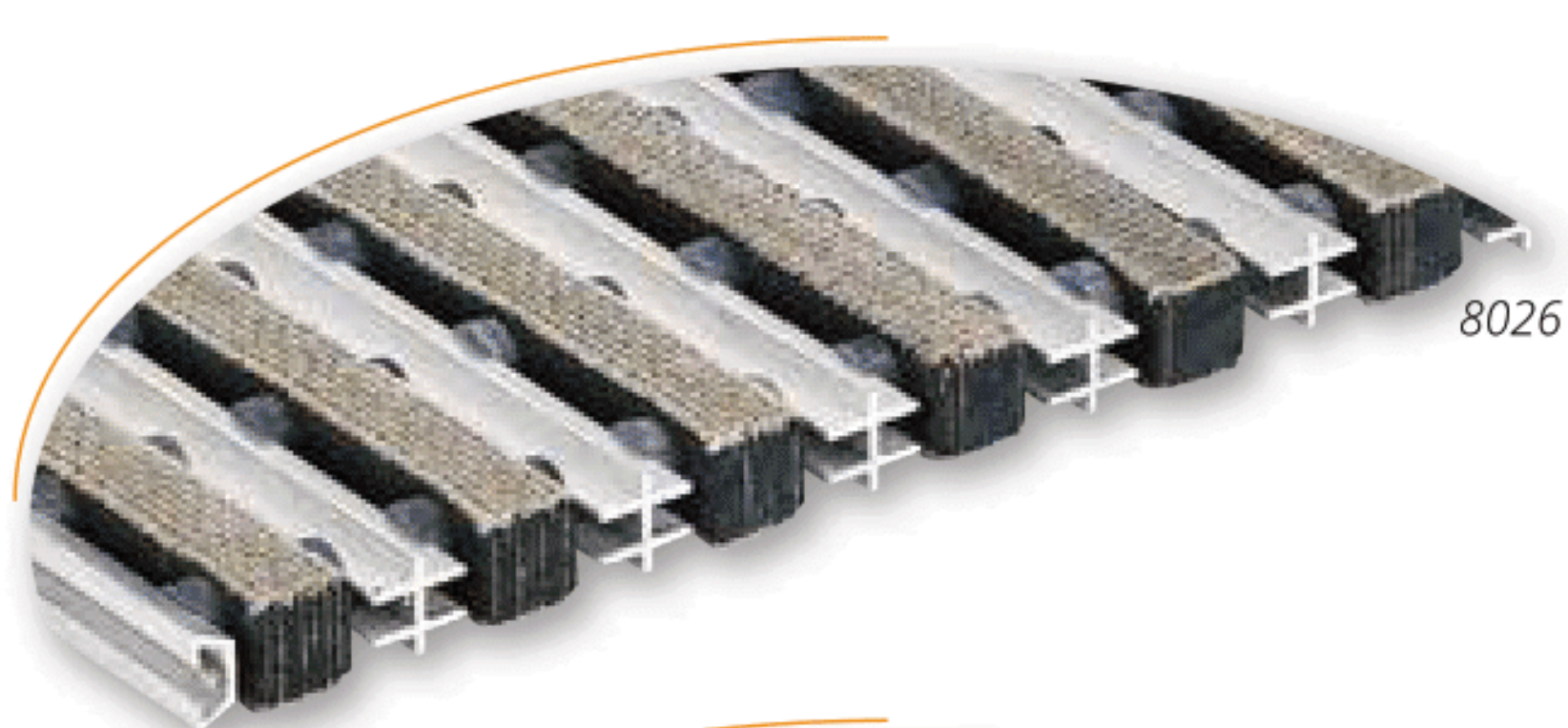
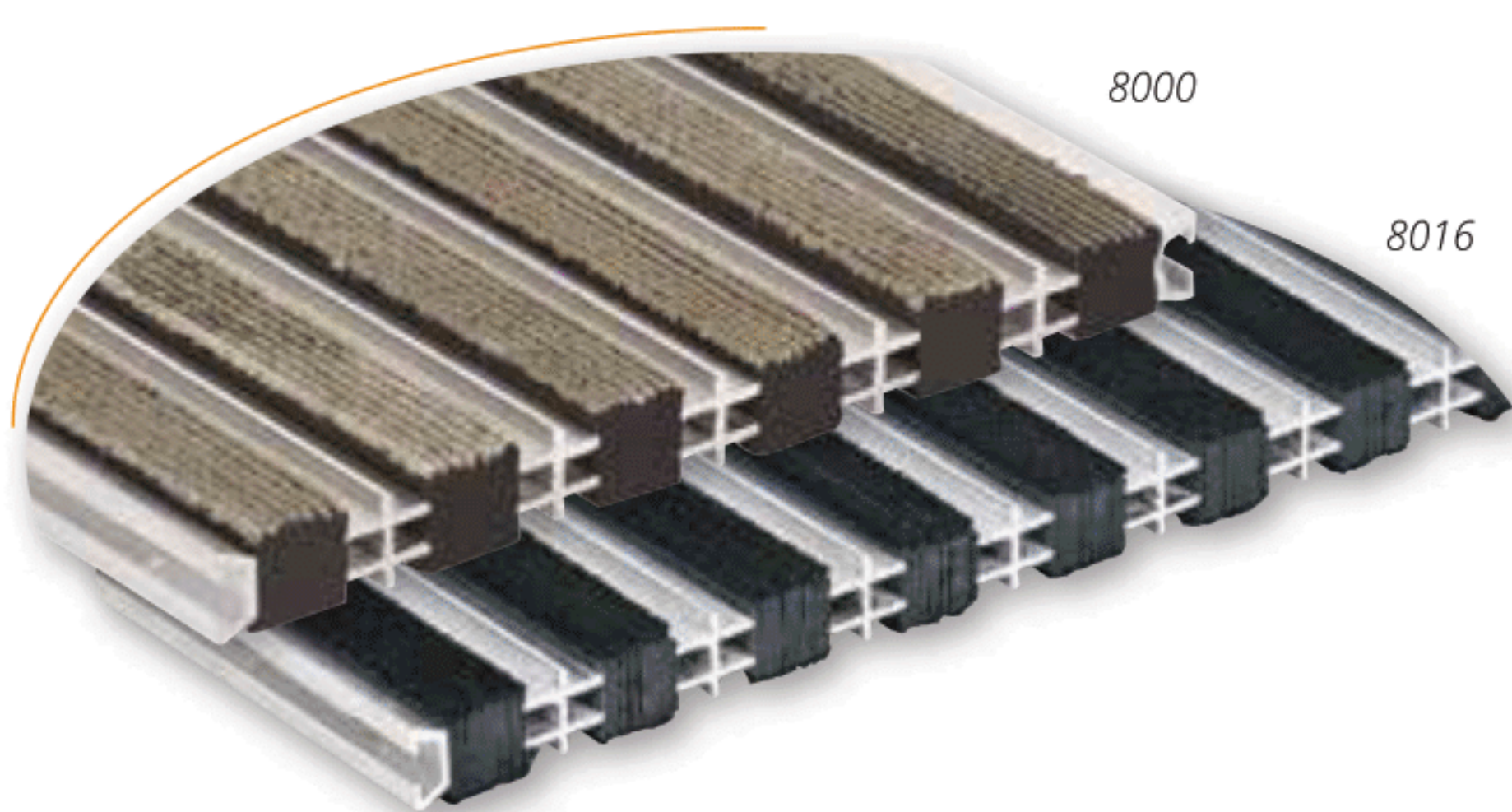

**+** Heavy traffic

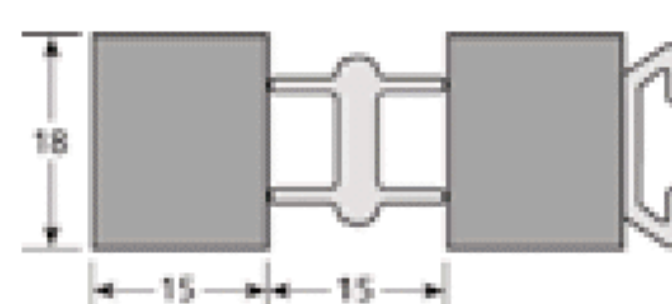

Single

AREA 2

Reference	Material	Colours	Price excl. VAT/m <sup>2</sup>
8000	Polyamide	Grey	
8016	Rubber closed	Black	

AREA 2

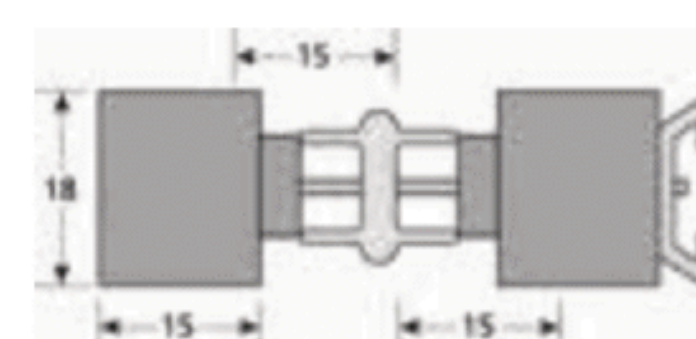

Single

Reference	Material	Colours	Price excl. VAT/m <sup>2</sup>
8026	Polyamide Rubber open	Grey	

**+** Slip resistance : R11

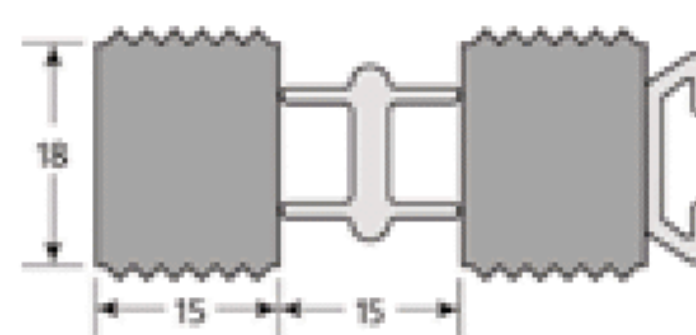

Single

AREA 1

Reference	Material	Colours	Price excl. VAT/m <sup>2</sup>
8030	Fluted rubber closed	Black	

AREA 2

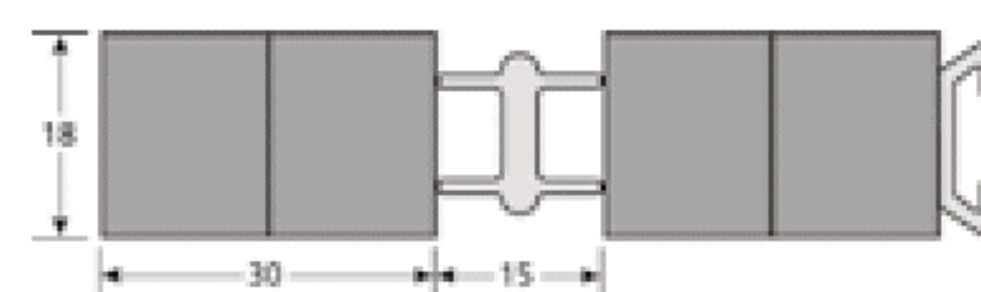

Double

Reference	Material	Colours	Price excl. VAT/m <sup>2</sup>
8005	Polyamide Rubber closed	Grey	

**!** Order form p.219



## ESPLANADE 1000



Made to measure

### ► CONSTRUCTION:

Esplanade 1000 is an entrance matting suitable for frequent pedestrian traffic; Dyed tufted nylon insert is dedicated for indoor and black PVC scraper wiper insert for indoor and outdoor. Inserts are supported with raw aluminium base, linked to each other with a PVC connector which deaden the noise. Edging strips are supplied for adjusting the mat dimensions to the matwell frame.

### ► MAINTENANCE:

Dirt from shoes is scraped by profiled ridge and retained by the absorbent inserts (nylon tuft) or wiped by fluted PVC inserts. The mat can be cleaned very easily, using a vacuum cleaner.

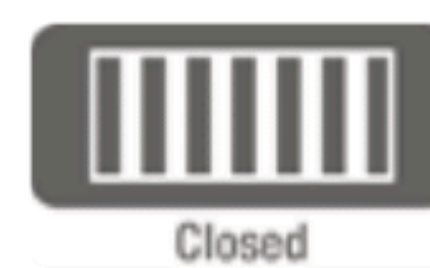

#### 1 Tufted brush Insert

100% nylon. Scraping and absorbent effect - Indoor use.

#### 2 Fluted PVC Insert

Black colour. Scrapes - Indoors / Outdoors.

### ESPLANADE 1000 - 12 MM

Price per m<sup>2</sup>

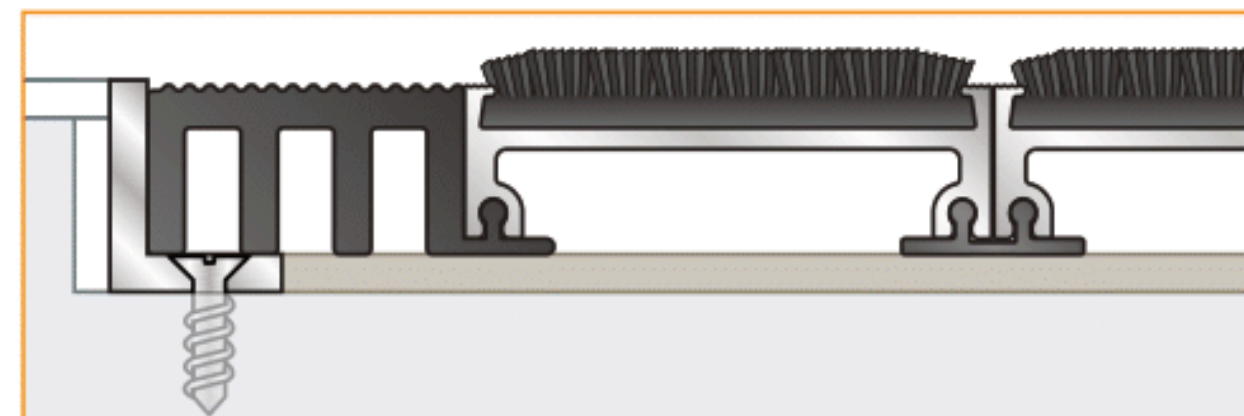
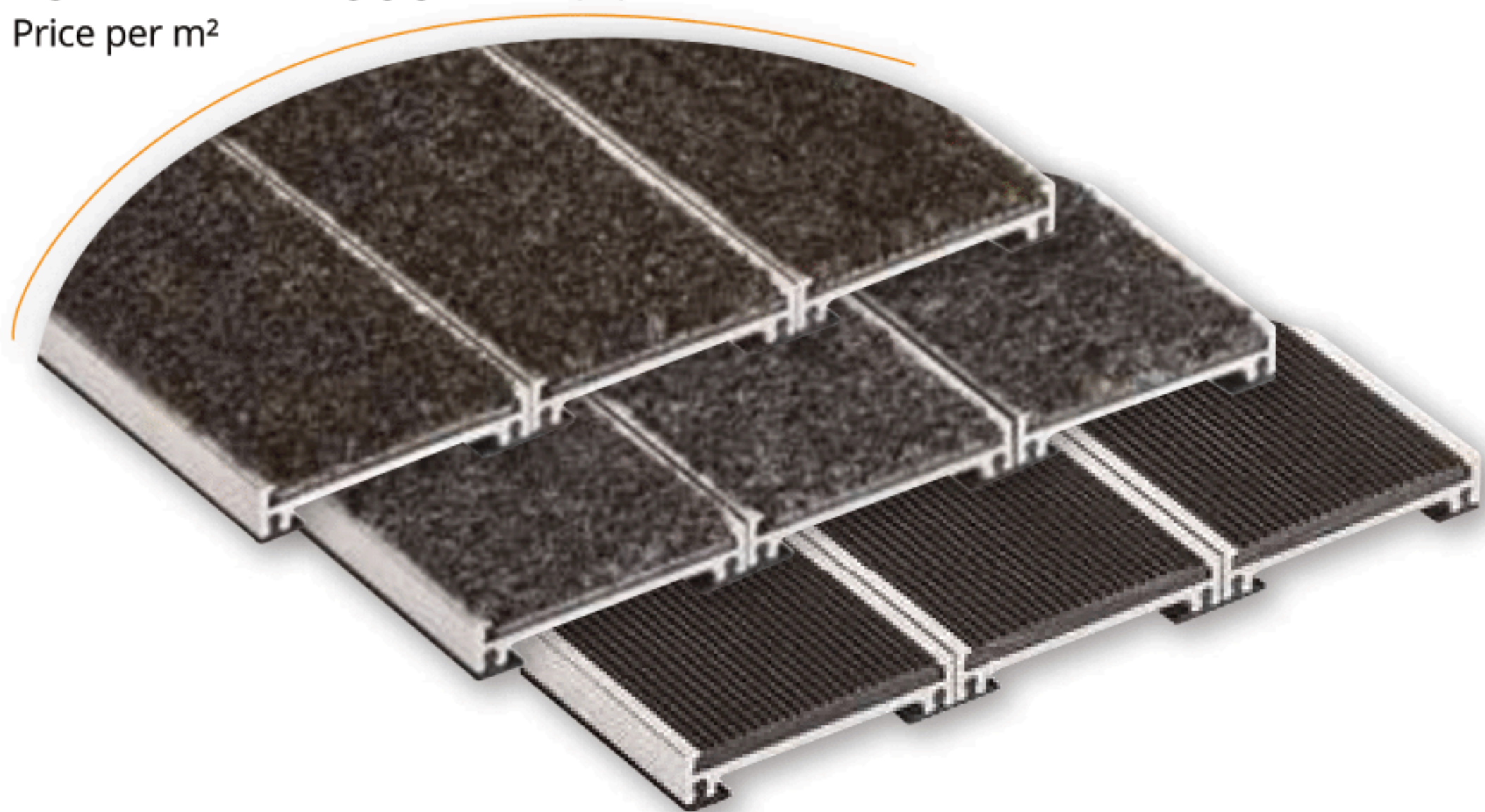

Rigid PVC finishing strips (to be cut) supplied on the ends of the mat and used for adjustment in the matwell.

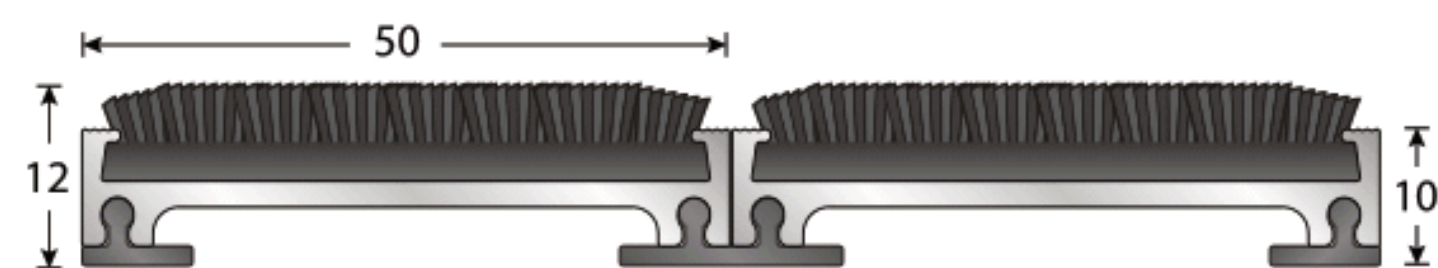

AREA 2	Reference	Material	Colours	Price excl. VAT/m <sup>2</sup>
	8640	Polyamide	Anthracite	
	8641		Grey	

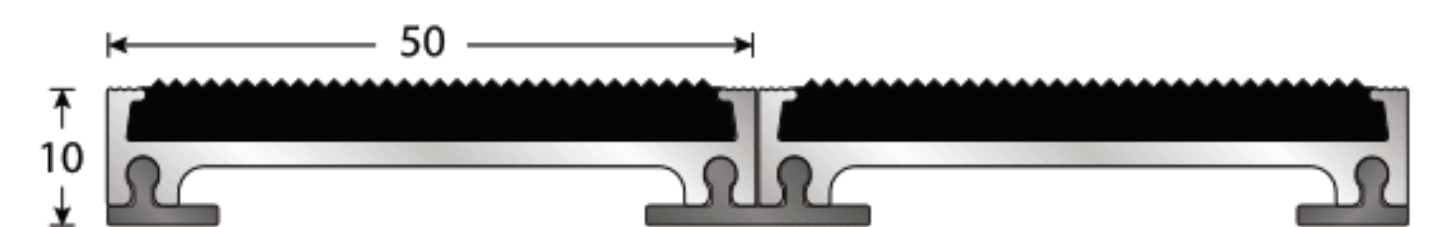

AREA 1	Reference	Material	Colours	Price excl. VAT/m <sup>2</sup>
	8644	Fluted PVC	Black	

### ESPLANADE 1000 - 18 MM

Price per m<sup>2</sup>

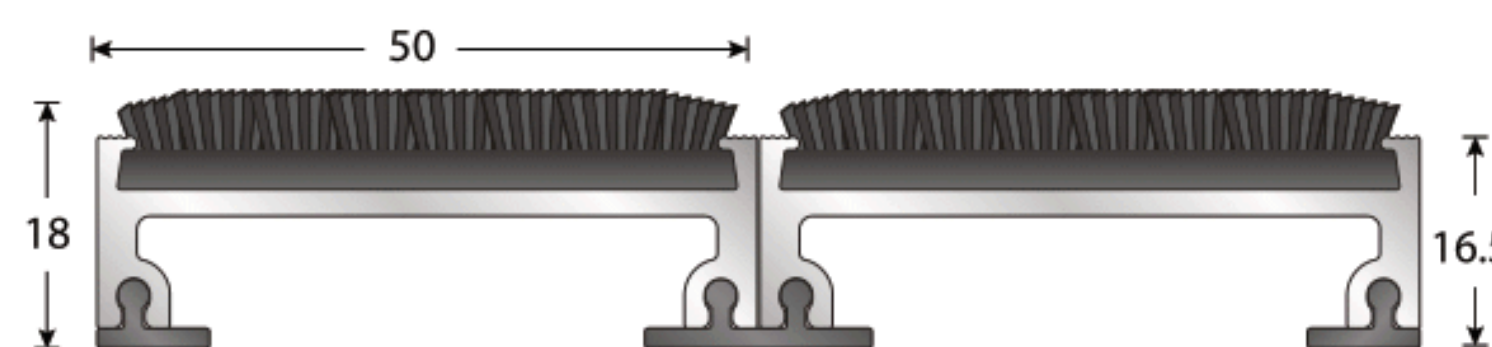
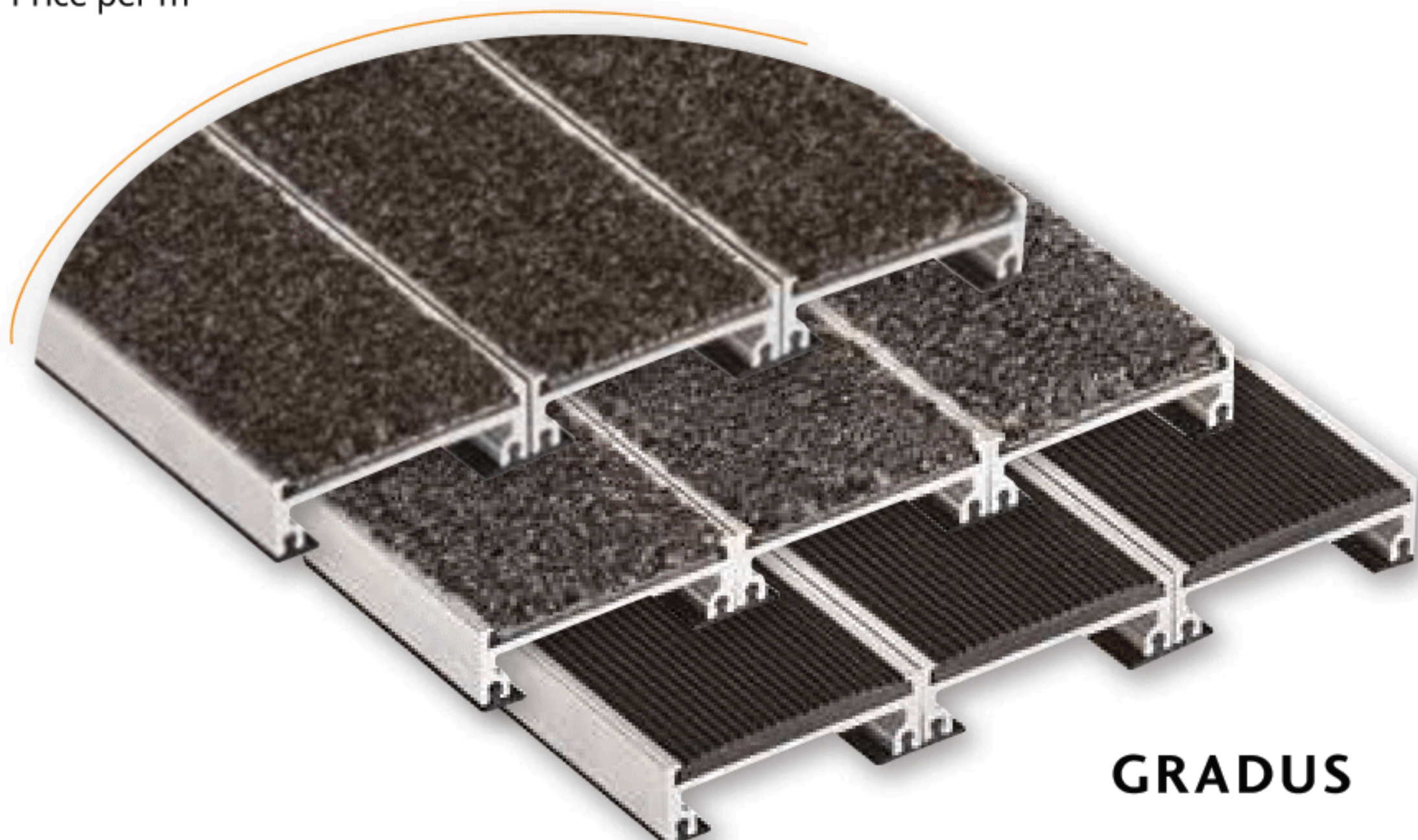

AREA 2	Reference	Material	Colours	Price excl. VAT/m <sup>2</sup>
	8650	Polyamide	Anthracite	
	8651		Grey	

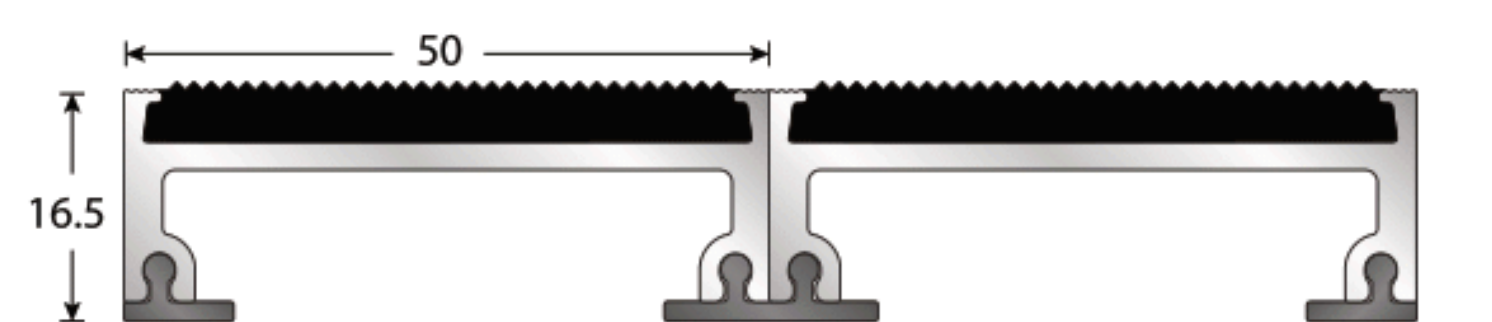

AREA 1	Reference	Material	Colours	Price excl. VAT/m <sup>2</sup>
	8654	Fluted PVC	Black	

GRADUS



ESPLANADE 1500



Cut: Made to measure

► CONSTRUCTION:

Esplanade 1500 is an entrance matting suitable for high pedestrian traffic; Dyed tufted nylon insert is dedicated for indoor and black PVC scraper wiper insert for indoor and outdoor. Inserts are supported with raw aluminium base, linked to each other with a PVC connector which deaden the noise. Edging strips are supplied for adjusting the mat dimensions to the matwell frame.

► MAINTENANCE:

Dirt from shoes is scraped by profiled ridge and retained by the absorbent inserts (nylon tuft) or wiped by fluted PVC inserts. The mat can be cleaned very easily, using a vacuum cleaner.

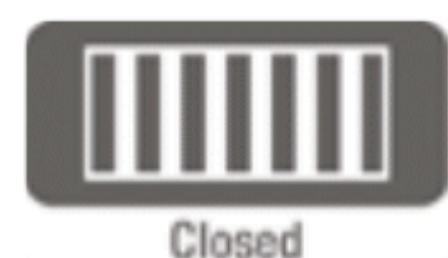
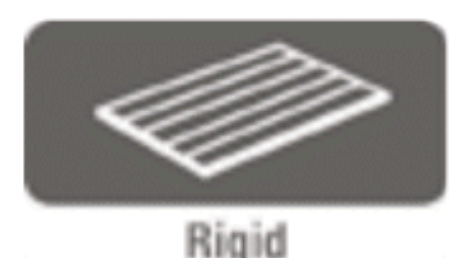

1 Loop pile Insert

100% polypropylene needle felt -Coarse denier-Scrapes / absorbs - Indoors

2 Fluted PVC Insert

Black colour. Scrapes - Indoors / Outdoors.

ESPLANADE 1500 - 20 MM

Price per m<sup>2</sup>

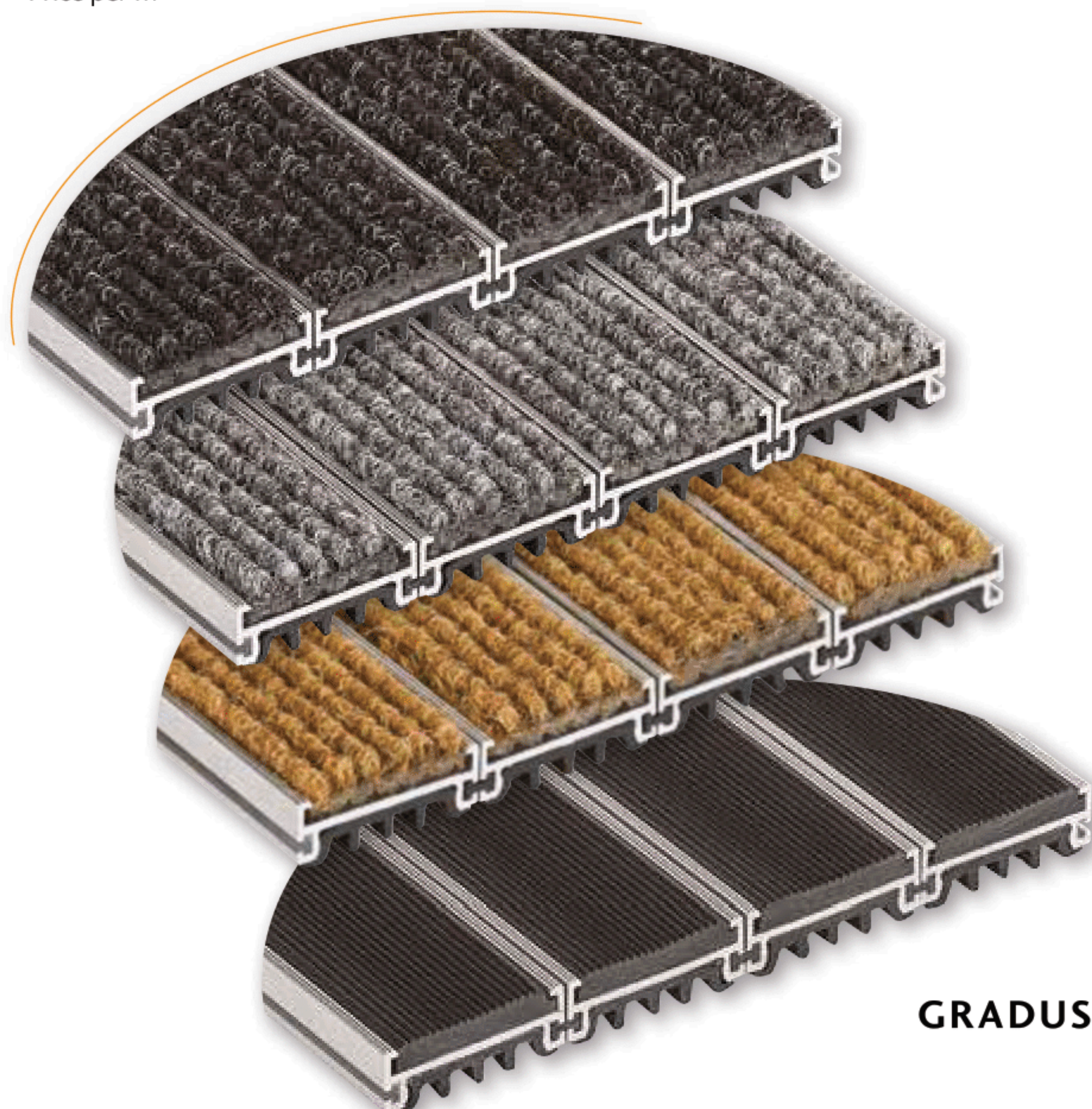

GRADUS

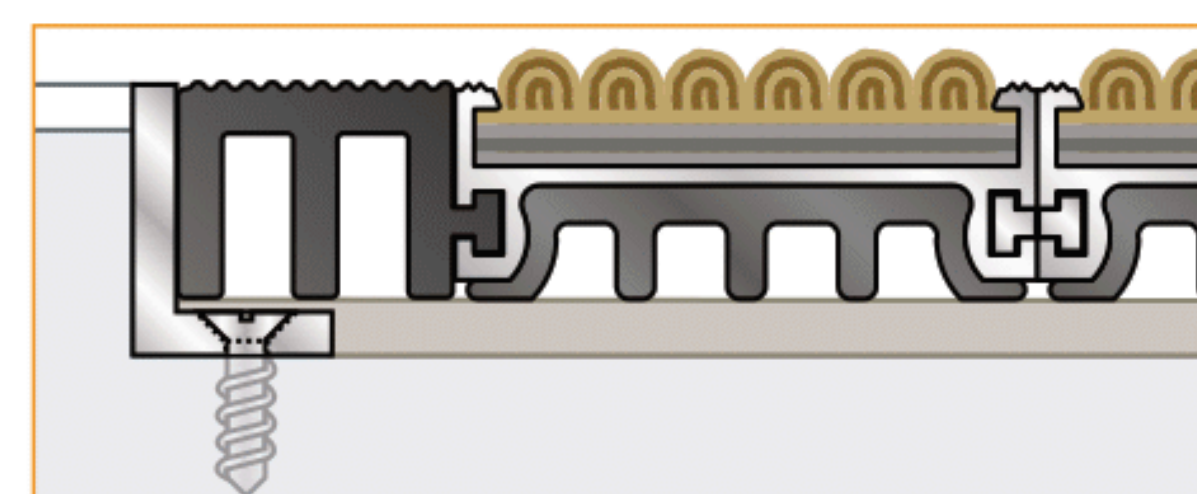

Rigid PVC finishing strips (to be cut) supplied on the ends of the mat and used for adjustment in the matwell.

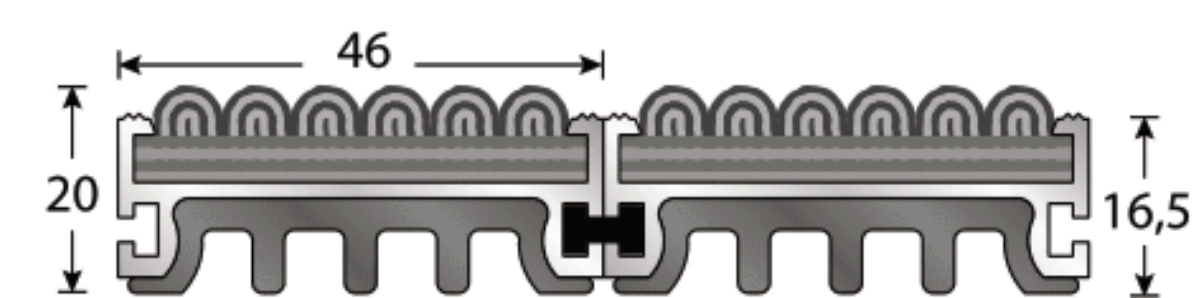

AREA 2

Reference	Material	Colours	Price excl. VAT/m <sup>2</sup>
8660	Loop pile Coarse denier	Anthracite	
8661		Grey	
8662		Coco	

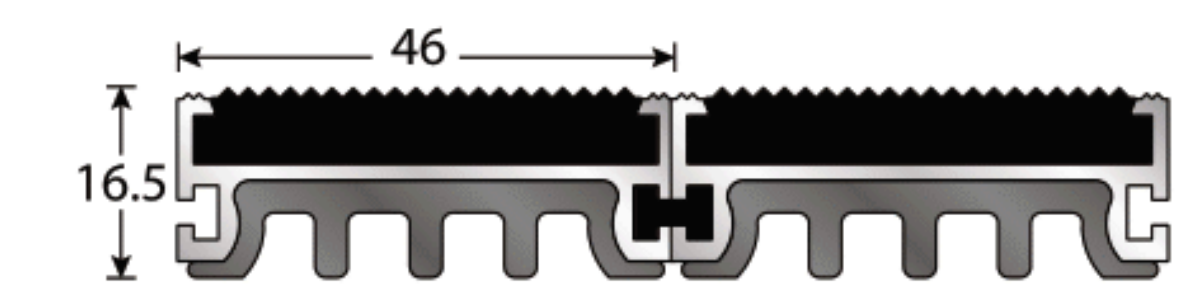

AREA 1

Reference	Material	Colours	Price excl. VAT/m <sup>2</sup>
8664	Fluted PVC	Black	

! Order form p.219